

**BMW 2008**  
The all-new  
1 Series  
Convertible

128i  
135i



**The Ultimate  
Driving Machine®**

Year One Of The 1.  
The all-new 2008 1 Series Convertible.



## 1 Series Convertible Product Ordering Guide

Confidential information for use by authorized BMW centers. Please note: images shown are low resolution. Due to color monitor and printer capabilities, colors shown may not appear on screen and print out accurately. Vehicle images in this Product Ordering Guide booklet may not be U.S. spec.

## Everything below you. Nothing above.

The all-new BMW 1 Series Convertible is your invitation to enjoy the delights of driving in the open air, combined with world-class style and spirited BMW performance.

A spiritual descendant of the world's first sports sedan, the 2002, the 1 Series is contoured and compact, with sensuous curves and a strong shoulder line. This sporty softtop offers a magnificent, fuel-efficient inline six-cylinder engine, and a 6-speed transmission for quick off-the-line response. Lightweight construction, an aluminum front suspension and near-perfect 50/50 weight distribution ensure that its quick acceleration is matched by tight and agile handling. The large, fade-resistant anti-lock brakes, enhanced with DSC

brake features such as Brake Drying and Brake Fade Compensation, quickly and confidently bring it to a full stop.

The sport-styled interior is inviting, with its quality construction and rich materials, such as the optional Boston Leather upholstery with Sun-Reflective Technology. Also like the 2002 before it, the 1 Series Convertible offers seating for four with a practical, remarkably spacious trunk that holds two golf bags – even with the top down.

The standard power softtop with heated glass rear window takes just 22 seconds to raise or lower – making the 1 Series Convertible one of the easiest, quickest and most enjoyable ways to put the wind in your hair and the world in your rear-view mirror. Liberation was never this much fun.





## Who says practicality can't be stunning?

The 1 Series Convertible exudes powerful style. Its strong shoulder line, long hood and short overhangs emphasize its rear-wheel-drive dynamic. BMW has differentiated the 135i with a full aerodynamic kit that adds a rear spoiler and black chrome-plated exhaust tips, 17" wheels, high-performance brakes, and sport-tuned suspension. By day, a choice of 10 paint colors and gleaming Star Spoke or V-Spoke light alloy wheels catch the light. By night, Corona

headlight-rings announce its arrival, while brilliant LED taillight clusters signal its departure.

Both models, when equipped with the optional Sport Package, receive run-flat performance tires, shadowline trim, bolstered sport seats, and an increased top-speed limiter. The 135i Sport Package is equipped with 18" wheels and an M sport steering wheel; the 128i receives 17" wheels and a sport-tuned suspension.





## Dynamic style meets pure comfort.

Strap yourself into the eight-way adjustable front seats with two-way headrests. Add the Sport Package for highly bolstered sport seats, or the Premium Package for the pleasures of power seats with memory and four-way power lumbar support, as well as Ambiance Lighting, auto-dimming mirrors with digital compass, three-button garage-door opener, and BMW Assist.™

In addition to standard Black or no-cost optional Taupe softtops, the optional Moonlight Black softtop – exclusive to the 1 Series Convertible – is interwoven with silver fibers, to produce a unique shimmery, silvery-black appearance in sunlight. The optional Comfort Access multi-function remote control can be used to lower or raise the softtop from outside the car. And even with the softtop down, BMW's unique Sun-Reflective Technology – included with optional Boston Leather upholstery – deflects the sun's infrared rays, so the surfaces stay cooler. The upholstery, available in five colors, can be combined with a choice of three attractive trims for total personalization.

## Luxurious functionality.

Enter the 1 Series and ignite the engine at a touch without using a key, courtesy of optional Comfort Access. The interior is beautifully crafted with quality materials, such as pearl gloss trim. On the leather-wrapped, multi-function steering wheel, Formula 1™- inspired paddle shifters are automatically included when the optional Sport Package and STEPTRONIC automatic transmission are ordered.

The optional Navigation system provides six programmable keys for easy access to audio selections and phone numbers (if equipped with compatible Bluetooth® wireless communication). Use the optional iPod® and USB adaptor to access songs and playlists from the steering wheel. Optional HD Radio™ and SIRIUS Satellite Radio provide everything a true audiophile could desire.





High performance:  
at the heart of the  
BMW 1 Series.



The 1 Series features two potent engine options to keep every ultimate driving urge satisfied. A 230-hp inline six-cylinder Valvetronic powerplant – capable of 200 lb-ft of torque at 2750 rpm – rockets the 128i from 0-60 in 6.4 thrilling seconds.<sup>1</sup> Under the hood of the 135i, BMW's award-winning twin-turbo 3.0-liter inline six draws on 300 hp, generating 300 lb-ft of torque from 1400-5000 rpm. Using a high-precision, piezo direct fuel injection system, every ounce of fuel is maximized, making the twin-turbo engine more efficient and overcoming the traditionally poor gas mileage of turbocharging.

Both models offer a choice of 6-speed transmissions. The silky-shifting manual comes standard, or choose the optional STEPTRONIC automatic with Adaptive Transmission Control. Whichever transmission you select, innovative engineering makes it possible to enjoy outstanding performance, reduced emissions, and fewer trips to the pump.

<sup>1</sup> 128i with manual transmission; 7.0 seconds with optional STEPTRONIC automatic transmission. 135i with manual transmission, 5.4 seconds; 5.5 seconds with optional STEPTRONIC automatic transmission.



You, the road,  
the sky. One.

Only BMW could endow the 1 Series with the precise engineering and performance innovations worthy of “The Ultimate Driving Machine.®” It starts with classic BMW rear-wheel drive and near-perfect 50/50 weight distribution for balanced handling when accelerating and braking on straightaways and in turns. An aluminum double-pivot front suspension, and a five-link fully independent rear suspension made of lightweight steel further hone its lightning-quick responsiveness.

Even in the most slippery conditions, BMW's Dynamic Stability Control (DSC)<sup>1</sup> and Dynamic Traction Control (DTC) help keep the 1 Series Convertible stable and going in the intended direction. Optional Active Steering automatically adjusts the steering ratio based on vehicle speed, for more immediate control at low to medium speeds, and more stability at highway speeds.

<sup>1</sup>In the 135i, DSC system is specifically designed for performance-oriented driving.

# 1 Series Convertible Exterior Paints

## Non-metallic

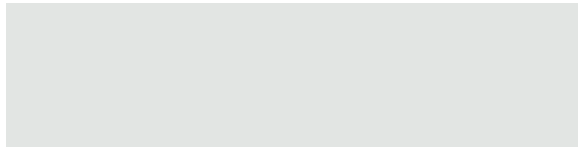

● **300** Alpine White



● **A61** Crimson Red

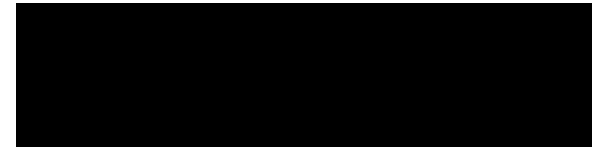

● **668** Jet Black

## Metallic



○ **A22** Sparkling Graphite Metallic



○ **A72** Cashmere Silver Metallic



○ **354** Titanium Silver Metallic



○ **896** Blue Water Metallic



○ **A51** Montego Blue Metallic



○ **A35** Monaco Blue Metallic

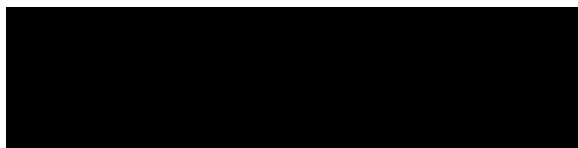

○ **475** Black Sapphire Metallic

Please note: Due to color monitor and printer capabilities, colors shown may not appear on screen and print out accurately.

- Standard equipment
- Optional equipment



# 1 Series Convertible Upholsteries

## Leatherette upholsteries



● **KAA5** Taupe Leatherette

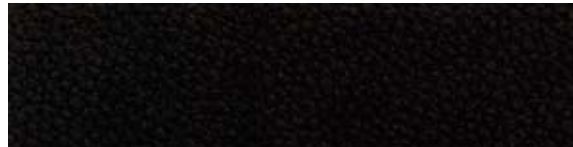

● **KASW** Black Leatherette

## Leather upholsteries



○ **LWB4** Savanna Beige/Black Boston Leather



○ **LWA5** Taupe Boston Leather



○ **LWAL** Gray Boston Leather



○ **LWD1** Coral Red Boston Leather

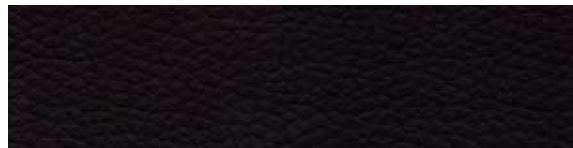

○ **LWSW** Black Boston Leather

Please note: Due to color monitor and printer capabilities, colors shown may not appear on screen and print out accurately.

- Standard equipment
- Optional equipment

# 1 Series Convertible Interior Trims and Softtop colors

## Interior trims

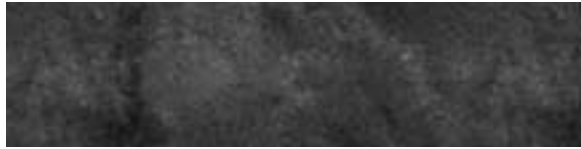

**4AS** Gray Poplar Wood ○ 128i ● 135i



**4A3** Light Burl Walnut Wood ○ 128i ▲ 135i



**4AT** High-Gloss Black ● 128i ▲ 135i

## Softtop colors

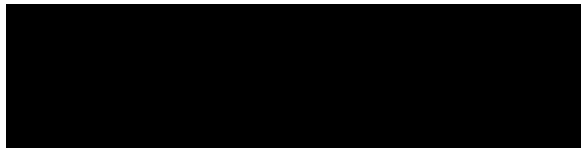

● **388** Black

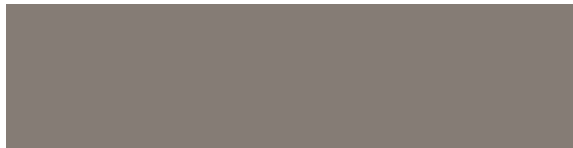

▲ **394** Taupe



○ **3YA** Moonlight Black



Please note: Due to color monitor and printer capabilities, colors shown may not appear on screen and print out accurately.

- Standard equipment
- Optional equipment
- ▲ No-cost option

The 1 Series Convertible is shown in optional Cashmere Silver Metallic paint with the optional Moonlight Black softtop.

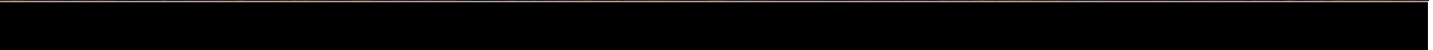

# 1 Series Convertible Recommended Color Combinations

Materials	Leatherette ●			Boston Leather <sup>1</sup> ○			
	KAA5 Taupe	KASW Black	LWB4 Savanna Beige/Black <sup>2</sup>	LWA5 Taupe	LWAL Gray	LWD1 Coral Red	LWSW Black
Upholstery colors							
Exterior paints							
<b>300</b> Alpine White Non-metallic ●	● ▲ ○	● ▲ ○	● ○	● ▲ ○	● ○	● ▲ ○	● ○
<b>A61</b> Crimson Red Non-metallic ●	● ▲ ○	● ▲ ○	● ○	● ▲ ○	● ○		● ▲ ○
<b>668</b> Jet Black Non-metallic ●	● ▲ ○	● ▲ ○	● ○	●	● ○	● ▲ ○	● ▲ ○
<b>A72</b> Cashmere Silver Metallic ○	● ▲ ○	● ▲ ○		● ▲ ○			● ▲ ○
<b>354</b> Titanium Silver Metallic ○		● ○			● ○	● ▲ ○	● ○
<b>A22</b> Sparkling Graphic Metallic ○	● ○	● ○		● ○	● ○	● ○	● ○
<b>A51</b> Montego Blue Metallic ○	● ▲ ○	● ▲ ○	● ○	● ▲ ○	● ○		● ▲ ○
<b>A35</b> Monaco Blue Metallic ○	● ▲ ○	● ▲ ○	● ○	● ▲ ○	● ○		● ▲ ○
<b>896</b> Blue Water Metallic ○	● ▲ ○	● ▲ ○	● ○	● ▲ ○	● ○		● ▲ ○
<b>475</b> Black Sapphire Metallic ○	● ▲ ○	● ▲ ○	● ○	● ▲ ○	● ○	● ▲ ○	● ▲ ○
Interior trims							
<b>4AS</b> Gray Poplar Wood <sup>3</sup>							
<b>4A3</b> Light Burl Walnut Wood <sup>4</sup>							
<b>4AT</b> High-Gloss Black <sup>5</sup>							

## Softtop colors

- **388** Black (Standard)
- ▲ **394** Taupe (No-cost option)
- **3YA** Moonlight Black (Optional)

<sup>1</sup>Leather upholstery: Optional, and included in optional Premium Package.

<sup>2</sup>Comes with Black carpet, door trim, door pockets and front armrests.

<sup>3</sup>Standard 135i interior trim; optional and available as a no-cost choice in optional 128i Premium Package.

<sup>4</sup>Optional trim available at no-cost in 135i; optional and available as a no-cost choice in optional 128i Premium Package.

<sup>5</sup>Standard 128i interior trim; available as a no-cost option in 135i.

- Standard
- Optional
- ▲ No-cost option

Please note: Due to color monitor and printer capabilities, colors shown may not appear on screen and print out accurately.

# Equipment

Performance and efficiency	128i	135i
3.0-liter dual overhead cam (DOHC), 24-valve inline 230-hp 6-cylinder engine with composite magnesium/aluminum engine block, Valvetronic, and Double-VANOS steplessly variable valve timing	●	
3.0-liter dual overhead cam (DOHC), 24-valve inline turbocharged 300-hp 6-cylinder engine with twin-turbo technology, piezo fuel injection, and Double-VANOS steplessly variable valve timing		●
Electronic throttle control	●	●
6-speed manual transmission	●	●
6-speed STEPTRONIC automatic transmission with Adaptive Transmission Control	○	○
Steering wheel-mounted paddle shifters <sup>1</sup>	○	○
<b>Handling, ride and braking</b>		
Dynamic Stability Control (DSC), including Brake Fade Compensation, Start-off Assistant, Brake Drying, and Brake Stand-by features, with Dynamic Traction Control (DTC)	●	●
Extensive aluminum componentry, including front suspension components (forged-aluminum lower arms); subframe; steering rack; and brake components	●	●
Aluminum double-pivot spring and strut-type suspension	●	●
5-link fully independent rear suspension in lightweight steel	●	●
Front and rear anti-roll (stabilizer) bars	●	●
Twin-tube gas-pressure shock absorbers	●	●
Sport suspension calibration	□	●
4-wheel ventilated anti-lock disc brakes with Dynamic Brake Control (DBC)	●	●
Active Steering	○	○
Increased top-speed limiter	□	□

- Standard
- Optional
- ▲ No-cost option
- Included in Sport Package
- ◇ Included in Premium Package
- ★ Included in Cold Weather Package

<sup>1</sup> When both optional Sport Package and optional STEPTRONIC automatic transmission are ordered, optional paddle shifters are included.  
<sup>2</sup> Run-flat tires do not come equipped with spare tire and wheel.  
<sup>3</sup> Performance tires are not recommended for driving in snow and ice. Due to low-profile tires, please note: wheels, tires and suspension parts are more susceptible to road hazard and consequential damages.

Exterior	128i	135i
V-Spoke (Style 255) 16 x 7.0 light alloy wheels and 205/55 run-flat <sup>2</sup> all-season tires	●	
Star Spoke (Style 142) 17 x 7.0 light alloy wheels and 205/50 run-flat <sup>2</sup> all-season tires		●
Star Spoke (Style 262) light alloy wheels, 17 x 7.0 front, 17 x 7.5 rear; 205/50 front, 225/45 rear run-flat <sup>2</sup> performance tires <sup>3</sup>	□	
Star Spoke (Style 264) light alloy wheels, 18 x 7.5 front, 18 x 8.5 rear; 215/40 front, 245/35 rear run-flat <sup>2</sup> performance tires <sup>3</sup>		□
Xenon Adaptive Headlights with auto-leveling, and Cornering Lights	○	●
Halogen free-form front foglights	●	
Retractable, high-intensity headlight washers	★	●
Heated dual power mirrors and heated windshield washer jets	●	●
Chrome-plated exhaust tips	●	
Black chrome-plated exhaust tips		●
Gray-band windshield	●	●
Fully lined power softtop with heated glass rear window and electric defroster	●	●
Black softtop	●	●
Taupe softtop	▲	▲
Moonlight Black (Anthracite with silver effect) softtop	○	○
Aerodynamic kit		●
Chrome-line exterior trim	●	●
Shadowline exterior trim	□	□
Metallic paint	○	○



Style 255

Style 142

Style 262

Style 264



# Equipment

Interior seating and trim	128i	135i
8-way adjustable front seats, including 2-way headrests	●	●
Manual height adjustment for front passenger seat	●	●
8-way power front seats with 2-way manual headrests and driver memory with 2 presets for seat and exterior mirror positions	○/◇	○/◇
8-way adjustable front sport seats with adjustable side bolsters, 2-way headrests and thigh support	□	□
8-way power front sport seats with adjustable side bolsters, 2-way manual headrests and thigh support, and driver memory with 2 presets for seat and exterior mirror positions <sup>4</sup>	□	□
4-way adjustable power lumbar support for front seats	◇	◇
Leatherette upholstery	●	●
Boston Leather upholstery with Sun-Reflective Technology	○/◇	○/◇
Gray Poplar Wood trim	○/◇	●
Light Burl Walnut Wood trim	○/◇	▲
High-Gloss Black trim	●	▲
3-stage heated front seats	○/★	○/★
3-spoke leather-wrapped multi-function sport steering wheel with audio and hands-free phone <sup>5</sup> controls	●	●
3-spoke M leather-wrapped multi-function sport steering wheel with audio and hands-free phone <sup>5</sup> controls		□
Door sills with chrome inserts	●	●

Comfort and convenience	128i	135i
Engine Start/Stop button	●	●
Comfort Access keyless entry with multi-function remote control; also allows raising and lowering of softtop via remote control	○	○
Automatic climate control – includes micro-filter, automatic air recirculation, left/right temperature control, temperature- and volume-controlled rear outlets, windshield misting sensor, MAX A/C, heat at rest, and recall of individual user settings	●	●
Front-door storage compartments	●	●
Front-seat center armrest	●	●
Front-seat cupholders	●	●
Tilt/telescopic steering wheel column	●	●
Park Distance Control (PDC) (rear only)	○	○
Interior and power-adjustable folding exterior mirrors with automatic-dimming function	◇	◇
Digital interior mirror compass	◇	◇
Power windows with “one-touch” up/down operation	●	●
Dynamic Cruise Control	●	●
BMW Ambiance interior lighting along doors and side of rear cabin	◇	◇
Locking glovebox	●	●
Through-loading system with integrated ski bag	○/★	○/★
Rain-sensing windshield wipers and Automatic headlight control	●	●
Integrated 3-button Universal garage-door opener	◇	◇
Pre-wiring for BMW center installation of mobile phone, alarm system	●	●

- Standard
- Optional
- ▲ No-cost option
- Included in Sport Package
- ◇ Included in Premium Package
- ★ Included in Cold Weather Package

<sup>4</sup> Optional power seats or Premium Package required.

<sup>5</sup> If equipped with optional Premium Package or BMW Assist™ Safety Services with **Bluetooth**® wireless technology. Requires BMW-approved **Bluetooth** enabled mobile phone.

# Equipment

Audio system	128i	135i
Anti-theft AM/FM stereo CD/MP3 player audio system with 10 speakers, Radio Data System (RDS), Auto-Store and 3-channel FM diversity antenna	●	●
Premium Hi-Fi anti-theft AM/FM stereo CD/MP3 player audio system with upgraded speakers (including 2 subwoofers), Digital Sound Processing (DSP), Radio Data System (RDS), Auto-Store and 3-channel FM diversity antenna; displays MP3 song title and artist	○	○
Auxiliary audio input for portable music players located in the center armrest	●	●
Pre-wiring for BMW center installation of 6-disc CD/MP3 changer, <sup>6</sup> satellite radio	●	●
SIRIUS Satellite Radio with one-year subscription	○	○
iPod® and USB adaptor (includes cable connector)	○	○
HD Radio™ with “multicast” FM station reception	○	○
<b>Instrumentation and controls</b>		
Service Interval Indicator with miles-to-service readout	●	●
Check Control vehicle monitor system with pictogram display, oil status display, and Condition Based Service indicator	●	●
Tire Pressure Monitor	●	●
On-board computer with Check Control – provides feedback on the vehicle’s operating status: oil level indicator and distance to next service appointment/oil change, as well as other detailed information, such as spark plug and micro-filter status. It also provides travel information – travel range on remaining fuel, external temperature, and more	●	●
BMW Navigation system with Voice Command System and Real Time Traffic Information (where available); iDrive system with high-function on-board computer and Controller, with 6 programmable memory keys	○	○

Safety and security	128i	135i
Anti-lock braking system (ABS)	●	●
Adaptive Brake Lights	●	●
BMW’s Advanced Safety System for integrated deployment of passive and active safety systems	●	●
Rollover Protection System	●	●
Driver’s and passenger’s front airbag supplemental restraint system (SRS) with advanced technology: dual-threshold, dual-stage deployment; and front-passenger seat sensors designed to prevent unnecessary airbag deployment	●	●
Front passenger seat-occupation recognition with Passenger’s Airbag Off indicator	●	●
Automatic safety-belt pretensioners at front seating positions	●	●
Front-seat-mounted side-impact airbags	●	●
Interlocking door anchoring system to help protect against door intrusion in side impacts	●	●
Central locking system with center console switch (leaves gas filler door unlocked), double-lock feature and 2-step unlocking	●	●
Coded Driveaway Protection	●	●
Automatic-locking retractors (ALR) on all passenger-seat safety belts for installation of child-restraint seat	●	●
LATCH attachments for child-restraint safety installation in rear seats	●	●
Crash sensor that automatically turns on hazard lights and interior lights, and unlocks doors	●	●
Programmable Daytime Running Lights	●	●
BMW Assist™ with <b>Bluetooth</b> ® wireless technology for hands-free calling (with <b>Bluetooth</b> enabled mobile phone), phonebook downloading and speech recognition capabilities	○/◇	○/◇

## BMW Services

BMW Ultimate Service™	●	●
-----------------------	---	---

● Standard

○ Optional

□ Included in Sport Package

◇ Included in Premium Package

★ Included in Cold Weather Package

<sup>6</sup> Available as an accessory.

<sup>7</sup> For complete details on BMW Ultimate Service, visit [bmwusa.com/owners/bmwultimateservice](http://bmwusa.com/owners/bmwultimateservice).

# Packages

Premium Package	128i	135i
8-way power front seats with 2-way manual headrests and driver memory with 2 presets for seat and exterior mirror positions	◇	◇
4-way adjustable power lumbar support for front seats	◇	◇
Boston Leather upholstery with Sun-Reflective Technology	◇	◇
Interior and power-adjustable folding exterior mirrors with automatic-dimming function	◇	◇
Digital interior mirror compass	◇	◇
BMW Ambiance interior lighting along doors and sides of rear cabin	◇	◇
Integrated 3-button Universal garage-door opener	◇	◇
BMW Assist™ with <b>Bluetooth</b> ® wireless technology for hands-free calling (with <b>Bluetooth</b> enabled mobile phone), phonebook downloading and speech recognition capabilities	◇	◇
Wood trim	◇	●



European image shown.

- Standard
- Optional
- ◇ Included in Premium Package
- Included in Sport Package
- ★ Included in Cold Weather Package

Sport Package	128i	135i
Star Spoke (Style 262) light alloy wheels, 17 x 7.0 front, 17 x 7.5 rear; 205/50 front, 225/45 rear run-flat <sup>8</sup> performance tires <sup>9</sup>	□	
Star Spoke (Style 264) light alloy wheels, 18 x 7.5 front, 18 x 8.5 rear; 215/40 front, 245/35 rear run-flat <sup>8</sup> performance tires <sup>9</sup>		□
8-way adjustable front sport seats with adjustable side bolsters, 2-way headrests and thigh support	□	□
8-way power front sport seats with adjustable side bolsters, 2-way manual headrests and thigh support, and driver memory with 2 presets for seat and exterior mirror positions <sup>10</sup>	□	□
Sport suspension calibration	□	●
3-spoke M leather-wrapped multi-function sport steering wheel with audio and hands-free phone <sup>11</sup> controls		□
Steering wheel-mounted paddle shifters <sup>12, 13</sup>	○	○
Shadowline exterior trim	□	□
Increased top-speed limiter	□	□

## Cold Weather Package

Through-loading system with integrated ski bag	★	★
3-stage heated front seats	★	★
Retractable, high-intensity headlight washers	★	●

<sup>8</sup> Run-flat tires do not come equipped with spare tire and wheel.

<sup>9</sup> Performance tires are not recommended for driving in snow and ice. Due to low-profile tires, please note: wheels, tires and suspension parts are more susceptible to road hazard and consequential damages.

<sup>10</sup> Optional power seats or Premium Package required.

<sup>11</sup> If equipped with optional Premium Package or BMW Assist™ Safety Services with **Bluetooth** wireless technology. Requires BMW-approved **Bluetooth** enabled mobile phone.

<sup>12</sup> Requires optional STEPTRONIC automatic transmission.

<sup>13</sup> When both optional Sport Package and optional STEPTRONIC automatic transmission are ordered, optional paddle shifters are included.

# Stand-alone Optional Equipment

Option Code		128i	135i
205	6-speed STEPTRONIC automatic transmission with Adaptive Transmission Control	○	○
2XA	Steering wheel-mounted paddle shifters <sup>14</sup>	○	
7XA	Steering wheel-mounted paddle shifters <sup>14</sup>		○
217	Active Steering	○	○
522	Xenon Adaptive Headlights with auto-leveling, and Cornering Lights	○	●
394	Taupe softtop	▲	▲
3YA	Moonlight Black (Anthracite with silver effect) softtop	○	○
MET	Metallic paint	○	○
459	8-way power front seats with 2-way manual headrests and driver memory with 2 presets for seat and exterior mirror positions	○/◇	○/◇
494	3-stage heated front seats	○/★	○/★
LW	Boston Leather upholstery with Sun-Reflective Technology	○/◇	○/◇
4AT	Black High-Gloss trim	●	▲
4A3	Light Burl Walnut Wood trim	○/◇	▲
4AS	Gray Poplar Wood trim	○/◇	●

Option Code		128i	135i
322	Comfort Access keyless entry with multi-function remote control; also allows raising and lowering of softtop via remote control	○	○
507	Park Distance Control (PDC) (rear only)	○	○
4UT	Through-loading system with integrated ski bag	○/★	○/★
677	Premium Hi-Fi anti-theft AM/FM stereo CD/MP3 player audio system with upgraded speakers (including 2 subwoofers), Digital Sound Processing (DSP), Radio Data System (RDS), Auto-Store and 3-channel FM diversity antenna; displays MP3 song title and artist	○	○
655	SIRIUS Satellite Radio with one-year subscription	○	○
6FL	iPod® and USB adaptor (includes cable connector)	○	○
653	HD Radio™ with "multicast" FM station reception	○	○
609	BMW Navigation system with Voice Command System and Real Time Traffic Information (where available); iDrive system with high-function on-board computer and Controller, with 6 programmable memory keys	○	○
639	BMW Assist™ with <b>Bluetooth</b> ® wireless technology for hands-free calling (with compatible <b>Bluetooth</b> enabled mobile phone), phonebook downloading and speech recognition capabilities	○/◇	○/◇



European screen shown.

- Standard
- Optional
- ▲ No-cost option
- ◇ Included in Premium Package
- Included in Sport Package
- ★ Included in Cold Weather Package

<sup>14</sup> When both optional Sport Package and optional STEPTRONIC automatic transmission are ordered, optional paddle shifters are included.



# Technical Data

Weight		128i	135i
Unladen weight	lbs	3494 (3571)	3660 (3671)

## Engine

Liters/type/valves per cylinder		3.0/inline 6/4	Turbocharged 3.0/inline 6/4
Displacement	cu cm	2996	2979
Nominal output @ rpm	hp	230 @ 6500	300 @ 5800
Maximum torque @ rpm	lb-ft	200 @ 2750	300 @ 1400-5000

## Performance

Top speed <sup>15</sup>	mph	130	130
Acceleration 0-60 mph <sup>16</sup>	sec	6.4 (7.0)	5.4 (5.5)

## Tires and wheels

Tire dimensions	standard	205/55	205/50
	Sport Package	front: 205/50 rear: 225/45	front: 215/40 rear: 245/35
Wheel dimensions	standard	16 x 7.0	17 x 7.0
	Sport Package	front: 17 x 7.0 rear: 17 x 7.5	front: 18 x 7.5 rear: 18 x 8.5
Material	standard	light alloy	light alloy

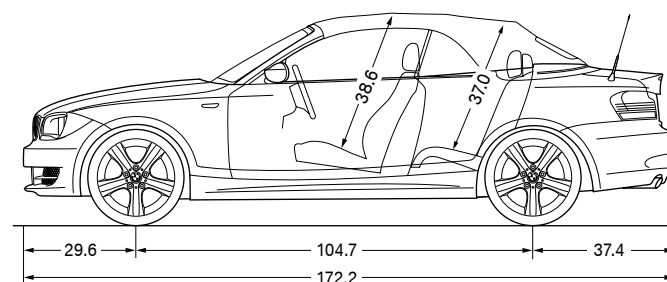
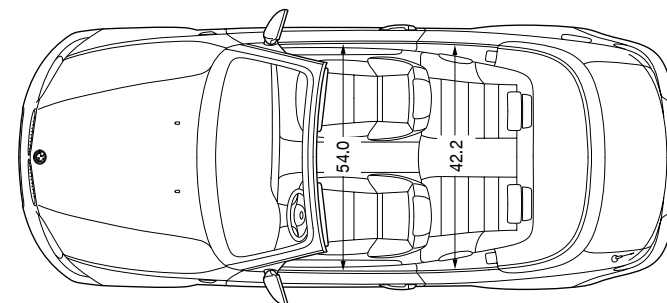
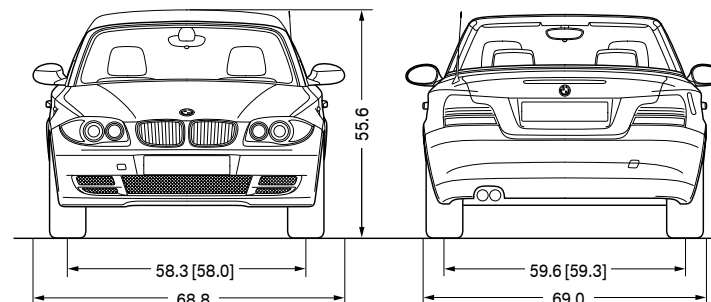

Illustrations above: all dimensions shown in inches, and apply to the 128i with Standard wheels. Figures in [ ] refer to 135i.

All technical information is preliminary.  
Figures in ( ) apply to vehicles with automatic transmission.

<sup>15</sup> Top speed limited electronically. All-season tires limited to 130 mph; Sport Package top-speed limiter increased to 150 mph.

<sup>16</sup> BMW AG test results. BMW urges you to obey all posted speed laws and always wear safety belts.

U.S. Importer: BMW of North America, LLC, Woodcliff Lake, NJ 07677. All illustrations and specifications contained in this brochure are based on the latest product information available at the time of printing. BMW reserves the right to make changes at any time, without notice, in colors, materials, equipment, specifications and models. BMW may, subject to legal requirements, determine the Model Year designation of its vehicles. The Model Year designation on any particular model may be longer or shorter than 12 months. Some vehicles pictured may contain non-U.S. equipment. Some models may be shown with optional equipment. While BMW NA makes all diligent efforts to provide accurate information in this brochure, there is no guarantee or warranty of accuracy. Furthermore, we do not assume any liability for the accuracy or completeness of information presented. Further information can be obtained from [bmwusa.com](http://bmwusa.com).

©2008 BMW of North America, LLC. Not to be reproduced wholly or in part without written permission from BMW of North America. The BMW name, model names and logo are registered trademarks. The Bluetooth word mark and logos are owned by the Bluetooth SIG, Inc. and use of such marks by BMW is under license. iPod is a registered trademark of Apple Inc. Other trademarks and trade names are those of their respective owners.

More about BMW

[bmwusa.com](http://bmwusa.com)  
1-800-334-4BMW



The Ultimate  
Driving Machine®

