

---

# Table of Contents

## Ignition Management

Subject	Page
<b>Ignition Management</b> .....	<b>3</b>
Principle of Operation .....	3
Ignition System Inputs .....	4
Ignition Coils .....	4
Spark Plugs .....	6
Knock Sensors .....	7
Superknocking .....	8
Multiple Ignition Pulses .....	9
Crankshaft Position/RPM Sensor (Hall Effect) .....	10
Crankshaft Sensor (N55) .....	11
<b>Service Information</b> .....	<b>13</b>
Ignition Coils .....	17
Knock Control .....	18
Spark Plugs .....	20
Spark Plug Diagnosis (HPI engines) .....	21
Engine Misfire Diagnosis .....	22
SI B 12 06 10 N54 -	
Misfire Faults, Diagnosis with ISTA .....	25
SI B 12 11 10 N54, N54T, N55 -	
Diagnosis for HDP High-pressure Faults .....	33

---

# Ignition Management

**Model: All**

**Production: All**

# OBJECTIVES

After completion of this module you will be able to:

- Understand how spark is formed and used in BMW engines
- Perform an ignition primary scope measurement
- Perform an ignition secondary scope measurement
- Interpret the spark measurements and relate them to diagnosis
- Understand optimized emission
- Describe how the ignition system is monitored

# Ignition Management

## Example of IPO for an Ignition Management System

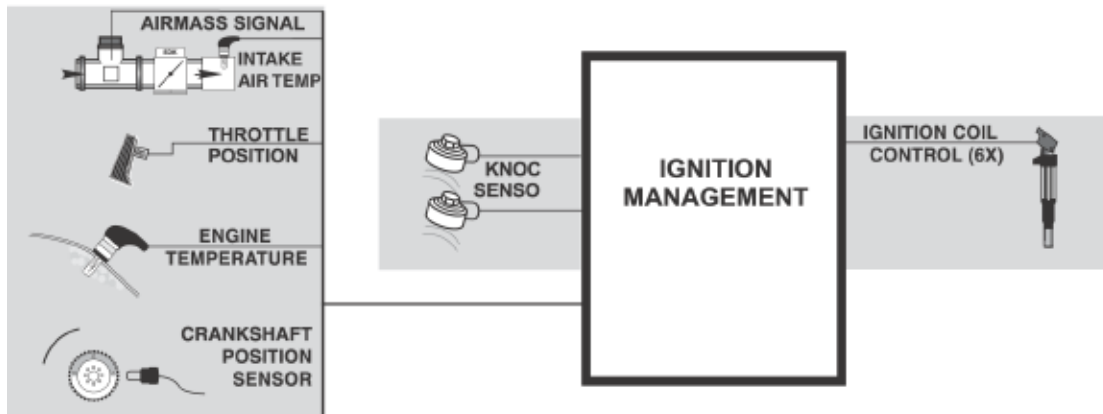

One of the main purposes of the ECM is Ignition Management which includes the actuation of several components. In the following pages you will find a generic explanation on how this system works. For more detailed information please access BMW Training Reference Manuals found on-line.

## Principle of Operation

Ignition Management provides ignition to the combustion chambers with the required voltage at the correct time. Based on the combination of inputs, the ECM calculates and controls the ignition timing and secondary output voltage by regulating the activation and dwell of the primary ignition circuits. The ECM controls and monitors the secondary ignition output including Misfire Detection.

The ECM has a very “broad” range of ignition timing. This is possible by using a Direct Ignition System, or sometimes referred to as “Static Ignition System” (RZV). Reliability is also increased by having separate individual ignition circuits.

The Ignition Control is determined by the ECM (load dependent). The ECM will calculate the engine “load” based on a combination of the following inputs:

- Battery Voltage;
- Accelerator Pedal Position;
- Air Flow Volume;
- Air Temperature;
- Engine Coolant Temperature;
- Crankshaft Position / RPM;
- Camshaft Positions (Cylinder ID);
- Knock Sensors;
- \*In a Turbocharged engine, Boost Pressure is also used.

---

The dwell time will be regulated based on battery voltage. When cranking, the voltage is low and the ECM will increase the dwell to compensate for saturation “lag time”. When the engine is running and the battery voltage is higher, the ECM will decrease the dwell due to faster saturation time.

The **Crankshaft Position/RPM** signals the ECM to start ignition in firing order as well as providing information about the engine operation. This input is used in combination with other inputs to determine engine load which **advances/retards the ignition timing**. Without this input, the ECM will not activate the ignition.

Cold start is determined by the ECM based on the engine coolant temperature and rpm during start up. A cold engine will crank over slower than a warm engine, the ignition timing will range between top dead center to slightly retarded providing optimum starting.

When starting a warm engine, the rpm is higher which results in slightly advanced timing.

If the engine coolant and intake air temperature is hot, the ignition timing will not be advanced reducing starter motor “load”.

## Ignition System Inputs

The ignition system on the engine management system uses several inputs to control ignition functions. Proper ignition timing control is dependent upon inputs such as RPM, throttle position, crankshaft position, air mass and temperature (coolant and intake air) and in our turbocharged engines, intake boost pressure.

Most of the ignition system components have remained the same for all NG6 engines. There are some minor changes to the ignition coils that apply to all versions. The coils have been optimized for more durability.

## Ignition Coils

The high voltage supply required to ignite the mixture in the combustion chambers is determined by the stored energy in the ignition coils. The stored energy contributes to the ignition duration, ignition current and rate of high voltage increase. The Coil circuit including primary and secondary components consists of:

The Coil Assembly contains two copper windings insulated from each other. One winding is the primary winding, formed by a few turns of thick wire. The secondary winding is formed by a great many turns of thin wire.



The primary winding receives battery voltage from the Ignition Coil Relay (in the IVM) which is activated by the CAS Module. The ECM provides a ground path for the primary coil (Coil Terminal 1) by activating a Final Stage transistor. The length of time that current flows through the primary winding is the “dwell” which allows the coil to “saturate” or build up a magnetic field. After this storage process, the ECM will interrupt the primary circuit at the point of ignition by deactivating the Final Stage transistor. The magnetic field built up within the primary winding collapses and induces the ignition voltage in the secondary winding.

The high voltage generated in the secondary winding is discharged through Coil Terminal 4 to the spark plug (insulated by the boot connector).

The primary and secondary windings are un-coupled, therefore, the secondary winding requires a ground supply (Coil Terminal 4a).

The high voltage generated in the secondary winding is discharged through Coil Terminal 4 to the spark plug (insulated by the boot connector).

The primary and secondary windings are un-coupled, therefore, the secondary winding requires a ground supply (Coil Terminal 4a).

The ECM uses “pencil type” ignition coils. The individual ignition coils are integrated with the insulated connector (boot).

The coils are removed by lifting the swivel latch connector retainer to release the wiring harness, apply a slight twist and lift the assembly upwards. The primary ignition cables are routed on the top of the cylinder head covers.

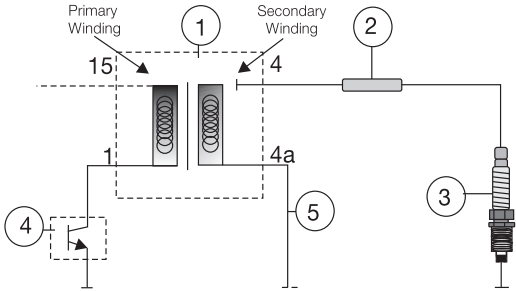

Index	Explanation
1	Coil Assembly
2	Insulator Boot
3	Spark Plug
4	ECM Final Stage Transistor
5	Secondary Coil Ground

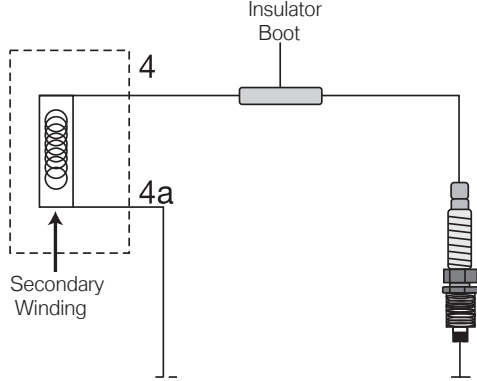

## Spark Plugs

The spark plugs introduce the ignition energy into the combustion chamber. The high voltage “arcs” across the air gap in the spark plug from the positive electrode to the negative electrodes. This creates a spark which ignites the combustible air/fuel mixture.

The spark plugs are located in the center of the combustion area (on the top of the cylinder heads) which is the most suitable point for igniting the compressed air/fuel mixture.

The spark plugs used on BMW Engines are designed by NGK. The plugs use an Iridium center electrode. The center electrode is only 0.6 mm thick. The insulator is also redesigned. The new spark plug technology allows for longer service life and improved cold starting. The correct spark plug for each engine should be used.

The Ignition System is monitored by the ECM via the **Crankshaft Position/RPM Sensor**. If a Misfire fault is present, the ECM will deactivate the corresponding fuel injector for that cylinder. Engine operation will still be possible.

The spark plugs for the N51 and N52KP remain the same as N52. However, the N54 uses a completely new spark plug from Bosch. The spark plug design consists of a 12mm thread which contrasts from the 14mm design on the N52 which prevents any possibility of improper installation. The hex on the spark plug is also a 12 point design which requires a special tool. The tool (socket) has a “thinwall” design to facilitate access in the confined area of the N54 cylinder head.



**Iridium is a precious metal that is 6 times harder and 8 times stronger than platinum, it has a 1,200° F higher melting point than platinum and conducts electricity better.**

---

## Knock Sensors

The knock sensor registers structure-borne vibrations (knocking). Knocking combustion can damage the engine. The data from the knock sensor make it possible for the DME to implement countermeasures. Abnormal, reverberating combustion processes can occur under certain conditions in petrol engines. These abnormal combustion processes curtail the earliest possible ignition timing point and therefore limit the power output and efficiency of the engine.



Such combustion processes are referred to as knocking and occur as the result of self ignition of the fuel-air mixture not yet reached by the flame front. Normal combustion and compression produced by the piston cause pressure and temperature to rise, resulting in self-ignition of the fuel-air mixture not yet ignited. This produces flame velocities in excess of 2000 m/s while the flame speed during normal combustion is approx. 30 m/s.

Conditions favoring knocking operation include:

- Increased compression ratio (e.g. deposits)
- High cylinder charge
- Poor fuel quality (RON/MON)
- High intake air and engine temperature

The knock sensors operate on the piezo electric principle. Vibrations from combustion events are converted into electrical signals which are monitored by the ECM. Excessive vibration indicates engine knock which will cause the ECM to retard the ignition timing to retard as necessary.

The number of Knock sensors will vary depending on the engine; typically 6 cylinder engines use two (2), V8's four (4) and V12's six (6).

**Note: Excessive knocking will cause the MIL to illuminate.**



**When installing knock sensors, be sure to torque to specification. Under or over-tightening the knock sensors can result in erroneous knock sensor faults or poor engine performance.**

**If a fault is detected with the sensor(s), the ECM deactivates Knock Control and it will set the ignition timing to a conservative basic setting based on intake air temperature/pressure and a fault will be stored.**

---

## Superknocking

The term superknocking refers to irregular combustion that occurs in turbocharged/supercharged engines. During this process, the maximum combustion pressure increases from approx. 100 bar up to about 200 bar. This situation could be caused by foreign bodies in the combustion chamber such as oil, residual gas or carbon particles that trigger ignition of the fuel-air mixture before the actual firing point.

Superknocking cannot be eliminated by corresponding interventions in the ignition system so to prevent engine damage, the ECM reduces the power output when it detects superknocking. Temporary superknocking is caused by individual dirt particles. Fuel injection into the affected cylinder is shut down in the short term (3 to 6 cycles) in response to superknocking. A corresponding fault code is stored in the fault code memory.





## Multiple Ignition Pulses

Multiple Ignition Pulses ensure good spark quality during engine start up. The ECM will activate the ignition coils 9 times (voltage dependent) per 720° of crankshaft revolution.

The ignition timing will be progressively advanced assisting the engine in coming up to speed. As the engine speed approaches idle rpm, the timing remains slightly advanced to boost torque. When the engine is at idle speed, minimum timing advance is required. This will allow faster engine and catalyst warm up.

The multiple pulsing switches to single pulse when:

- Engine Speed >1350 RPM (varied with engine temperature)

The timing will be advanced when the ECM observes low engine rpm and increasing throttle/air volume inputs (acceleration torque). As the throttle is opened, the ECM advances the timing based on engine acceleration and at what rate. The ECM will fully advance timing for the “full throttle” position indicating maximum acceleration (torque).

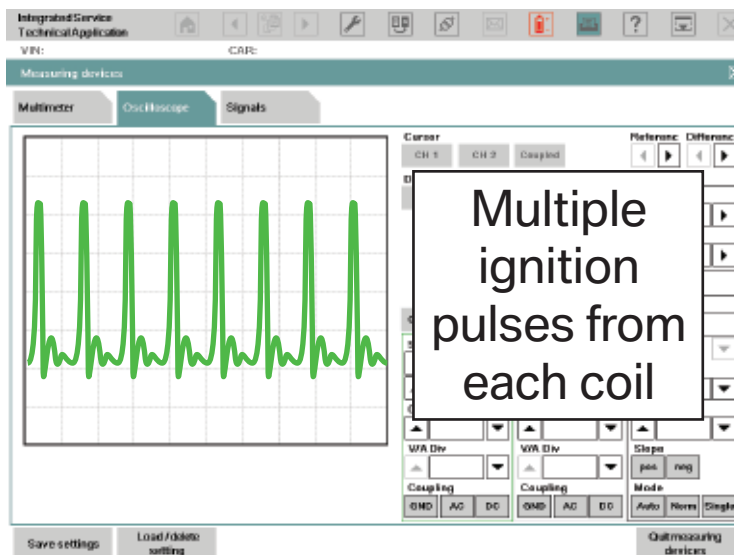
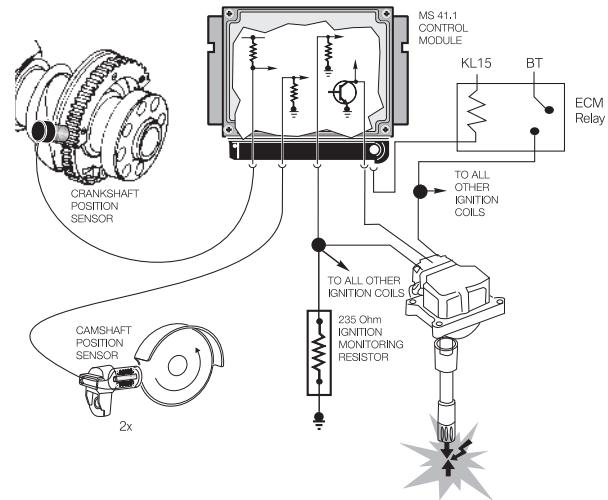

## Crankshaft Position/RPM Sensor (Hall Effect)

The crankshaft position sensor provides the ECM with a 5 volt square wave signal. The ECM calculates engine speed (RPM) and crankshaft position for ignition and injection system operation.

The sensor is supplied with 12 volts from the engine electronics fuses and ground from the ECM.

An effective signal that can be evaluated is output as from a speed of approx. 20 rpm.

The control unit detects the tooth gap in that the measured spacing of the gaps is more than double as great as the previous or subsequent gaps. The tooth gap itself is assigned to a defined crankshaft position of cylinder number 1. The DME synchronizes the crankshaft position with respect to this timing point. With each subsequent low signal it increments the crankshaft position by 6°.

Exact assignment is necessary for the DME to be able to adapt the ignition and fuel injection to specific requirements. The time interval measured between two level changes (e.g. High to Low) is therefore divided into smaller units of time.

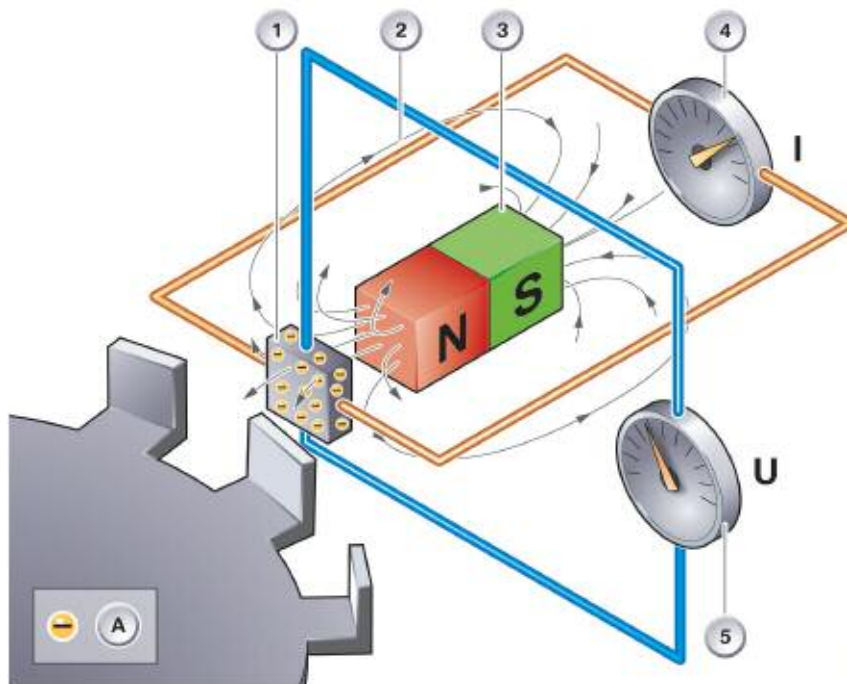

Index	Explanation
A	Electrons
1	Hall Module
2	Lines of magnetic force
3	Permanent magnet
4	Power supply
5	Hall voltage



**The crankshaft position sensor is also monitored for variations in crankshaft speed to determine misfires.**

---

### Crankshaft Sensor (N55)

The function of the new crankshaft sensor is identical to that of the crankshaft sensors used for the automatic engine start-stop function (MSA). The engine reversal detection is required for the MSA function. (MSA is not currently offered in the US.)



Index	Explanation
1	Connector
2	Dust seal
3	Sensor

---

NOTES

PAGE

## Service Information

A fault survey should first be performed using the IMIB to determine if there is a fault in the primary ignition or secondary ignition. If there is a fault in the primary ignition, testing should include:

- Power Supply at the coil (KL 15).
- Resistance of the harness and ignition coil primary winding using the Universal Adapter with the ECM disconnected.

If there is a fault in the secondary ignition, testing should include:

- Primary Ignition.
- Evaluation of Secondary Oscilloscope Patterns.

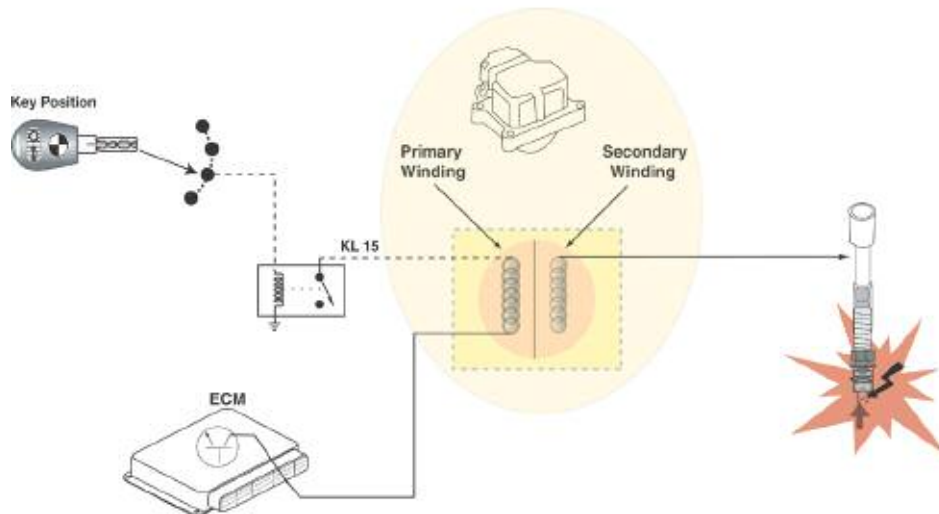

**The Following are Examples of Secondary Oscilloscope Patterns**  
(consult Repair Instructions for ignition pattern variations per coil manufacturer):

This is a normal pattern for one ignition circuit with the engine at idle speed.

- Normal Combustion Period.
- Normal Ignition Voltage Peak.

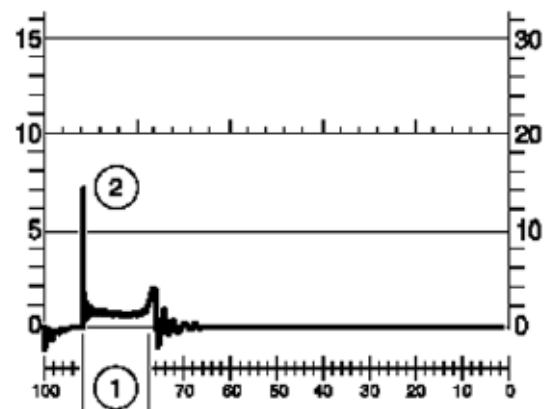

**Multiple Ignition Pulses** ensure good spark quality during engine start up. The ECM will activate the ignition coils 9 times per 720° of crankshaft revolution.

This is a normal pattern for one ignition circuit when:

1. Normal Combustion Period
2. Normal Ignition Voltage Peak

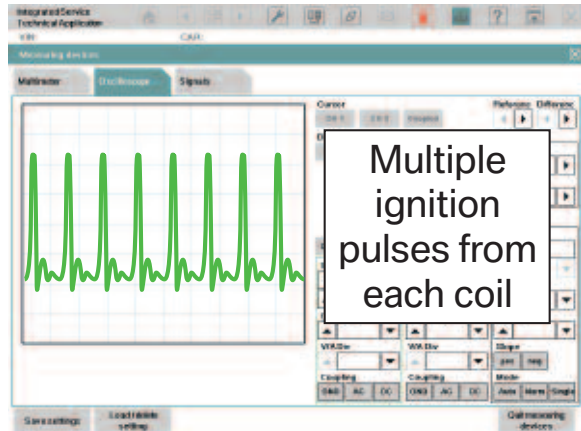

Long Spark Period (1) with Low Ignition Voltage Peak (2). If Spark Period is Fluctuating:

- Indicates Low Compression
- Contamination on Spark Plug or Defective Spark Plug

If instead you measured a Short Spark Period (1) with High Ignition Voltage Peak (2):

- Defective Ignition Connector or Resistive Adaptive Boot

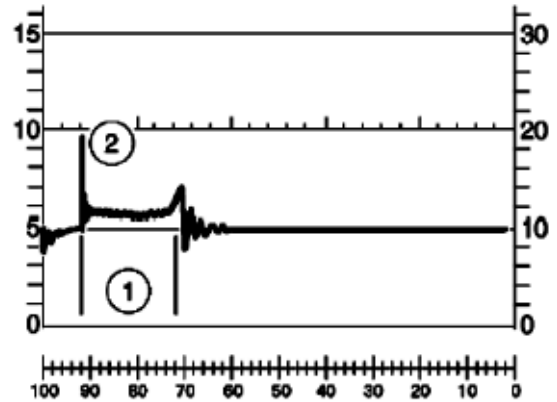

Evaluation of Ignition Voltage Peaks at Idle Speed (Multiple Cylinders Displayed).

1. Normal Attenuation (Voltage Reduction) Process
2. Shorten Attenuation Process (arrow)- Defective Ignition Coil
3. Absence of Attenuation (arrow )-Defective Ignition Coil

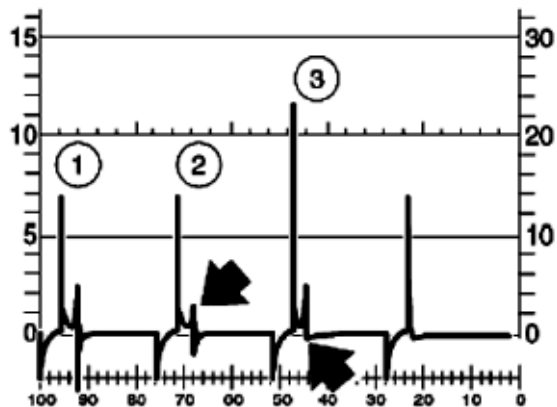

No Sparking Voltage Line (Single Cylinder Displayed)

- Defective Ignition Coil.

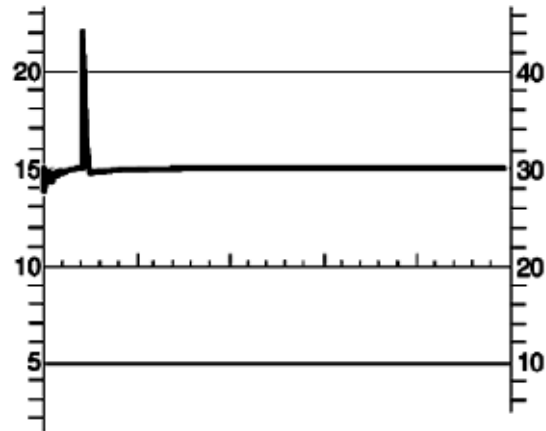

Evaluation of Ignition Voltage Peaks under Sudden Loads (Multiple Cylinders Displayed).

- Defective Ignition Coil.

Decaying Process is considerably Higher than Ignition Voltage Peak (2):

- Lean Mixture.
- Defective Fuel Injector.
- Low Compression.

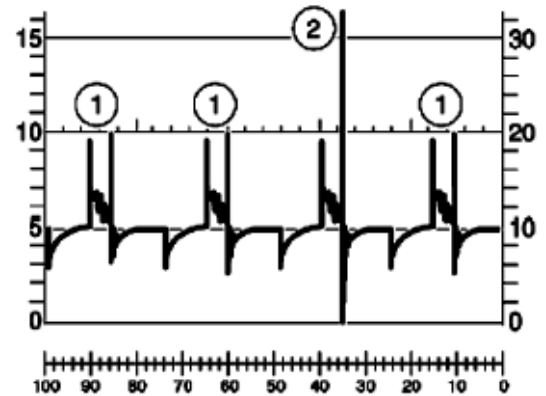

**Allow at least 3 minutes to elapse after the key was set to the “OFF” position before disconnecting the ECM. This will allow sufficient time to complete the DM-TL test. Voltage may be present (up to 3 minutes) causing damage to the ECM if it is disconnected during this time period (arcing).**

**The Repair Instructions should be consulted for additional Oscilloscope Patterns under various engine speeds.**

When Testing the Secondary Ignition System, use Special Tool (Secondary Voltage Test Cable) **#90 88 6 127 050 / SWZ 12 7 050** This provides a clamping surface for the IMIB primary and secondary ignition adapter clamps.

**CAUTION!!!**

**Observe safety precautions, high voltage is present with the engine running!**

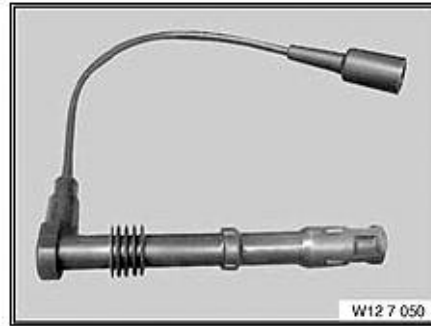

The ignition current circuit is monitored based on the current in the primary coil. When switching on, the current must be within certain values during defined time thresholds.

The following items are monitored:

- Primary current circuit of ignition coil.
- Ignition wiring harness.
- Secondary current circuit of ignition coil with spark plug.
- Spark duration.

The following defects are detected by the ignition circuit monitoring:

- Short-circuit on primary side of ignition coil.
- Spark plug.
- Line break in ignition wiring harness.
- Defective ignition output stages.

The following **are not detected**:

- Sporadic faults such as loose contacts in the ignition wiring harness.
- Sparkover in the high voltage circuit parallel to the spark gap without producing an interturn fault.



---

## **In Summary,**

If the Secondary Ignition Voltage is Too High (Excessive Resistance for Ignition):

- Spark Plug Gap is too Large (Worn or Burned).
- Incorrect Heat Range Spark Plug.
- Compression is too High (Carbon, etc.).
- Interruption in the Secondary Ignition Connector or Resistive Adapter Boot.

If the Secondary Ignition Voltage is Too Low (Low Resistance for Ignition):

- Spark Plug Gap is Too Small (Mishandled on Installation).
- Incorrect Heat Range Spark Plug.
- Compression is Too Low.
- Voltage Leak in the Secondary Ignition Connector or Resistive Boot to Ground.

## **Ignition Coils**

The ignition coils of BMW engines have been redesigned for better rigidity and durability. Particular care must be taken when working on the fuel system to ensure that the ignition coils are not wet with fuel. The resistance of the silicone material is greatly reduced by contact with fuel. This could compromise the coils insulation and result in arcing at the top of the spark plug causing a misfire.

- The ignition coils must be removed before working on the fuel system.
- When installing new solenoid valve fuel injectors utmost cleanliness must be observed.
- After removing the ignition coils use a rag to prevent fuel from entering the spark plug well.
- Ignition coils that have been saturated with fuel must be replaced.

## Knock Control

Knock Control allows the ECM to further advance the ignition timing under load for increased torque. Knock Control is only in effect when the engine temperature is greater than 35°C and there is a load on the engine. This will disregard false signals while idling or from a cold engine.

Based on the firing order, the ECM monitors the Knock Sensors after each ignition for a normal (low) signal.

If the signal value exceeds the threshold, the ECM identifies the “knock” and retards the ignition timing (3°) for that cylinder the next time it is fired. This process is repeated in 3° increments until the knock ceases.

The ignition timing will be advanced again in increments to just below the knock limit and maintain the timing at that point.

If a fault is detected with the Knock Sensor(s) or circuits, the ECM deactivates Knock Control. The ignition timing will be set to a conservative basic setting (to reduce the risk of detonation) and a fault will be stored. The “Malfunction Indicator Light” will be illuminated when the OBDII criteria is achieved.

The Knock Sensors should be tested using the IMIB for:

- Fault Codes
- Status Display - Knock Control (active / not active)
- Oscilloscope Display (Low AC Voltage -mV setting)

### When installing Knock Sensors:

- **Do not mix the locations! or Engine Damage will result!** The Knock Sensors use a combined connection to the engine harness. The Knock Sensor with the shorter cable is for cylinders 4 - 6.
- **Do not over tighten attaching bolt!** - Piezo ceramic will be cracked. Torque to 20 nm.
- **Do not under tighten attaching bolt!** A loose sensor can vibrate producing a similar signal to a knock.

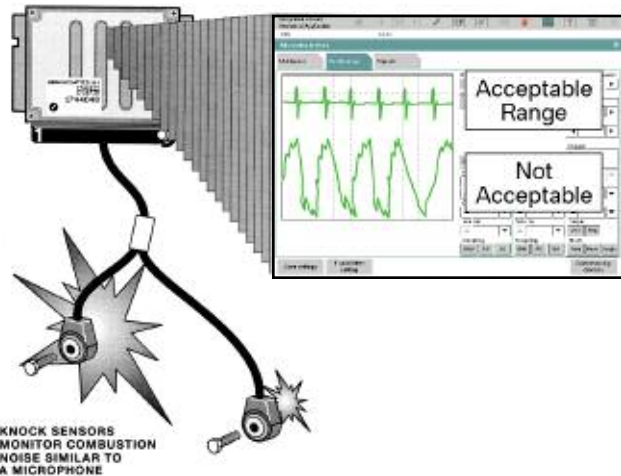

---

Conditions favoring knocking operation include:

- Elevated compression ratio.
- High cylinder charge.
- Poor fuel quality (RON/MON).
- High intake air and engine temperature.

Self-diagnosis of the knock control system comprises the following checks:

- Check for signal error, e.g. line break or plug connection defective.
- Self-test of evaluator circuit.
- Check of noise level registered by the knock sensor for the engine.

Knock control is switched off if an error is determined in one of these checks. In this case, an emergency program controls the ignition timing. At the same time, a corresponding fault code is entered in the fault code memory. The emergency program ensures safe, damage-free operation. The emergency program depends on the load, engine speed and engine temperature.

---

## Spark Plugs

The Spark Plugs should be inspected for the proper type, gap and replaced at the specified intervals.

Refer to the Service Information Bulletins:

- SI B 12 01 05 High Performance Iridium Spark Plug/Spark Plug Application Chart
- SI B 12 01 99 High Performance Platinum Spark Plug/Spark Plug Application Chart for the proper type and a visual of the spark plug (showing effects of combustion, fouling, etc.)

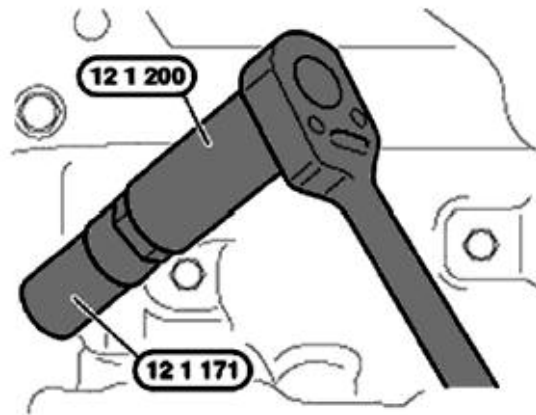

The Spark Plugs should be properly installed and torqued using the following Special Tools:

- SWZ 12 1 200 Torque Limiter
- SWZ 12 1 171 Spark Plug Socket



**Never use Air Tools for removal or installation.**

## Spark Plug Diagnosis (HPI engines)

Due to the proximity of the spark plug to the fuel injector nozzle, any divergence in the fuel spray may cause possible spark plug damage. This makes spark plug diagnosis an important part of HPI engine service concerns. Information gained by the spark plug diagnosis may indicate possible fuel injector faults. Spark plug replacement interval has been reduced to 45,000 miles on this engines. The illustrations below can be used to assist in spark plug diagnosis:



The spark plug above shows a normal wear pattern with no excessive electrode wear or insulator damage.



The spark plug above shows a normal wear pattern for a spark plug with high mileage. Spark plug is due for replacement.



The spark plug above shows erosion of the electrode on one side which could be an indication of fuel spray "diversion".



The spark plug above shows erosion of the electrode on one side and damage on the insulator nose. This could also be an indication of fuel spray "diversion".

## Engine Misfire Diagnosis

Engine Misfire is the result of inefficient combustion in one or more cylinders. The causes of Engine Misfire are extensive but can be grouped into the following sub-systems. Consider the charts below as an additional diagnostic aid once ISTA is connected, the correct fault symptom has been chosen and the fault memory has been interrogated. Follow the Test Module as displayed by ISTA.

IGNITION SYSTEM			
COMPONENT	POSSIBLE CONDITION	TEST	CORRECTION
<b>Spark Plug:</b>	<ul style="list-style-type: none"> <li>• Incorrect spark plug installed</li> <li>• Electrode gap closed or too small</li> <li>• Electrode(s) missing</li> <li>• Oil or fuel fouled spark plug</li> <li>• Ceramic insulation cracked</li> </ul>	Secondary Ignition	<ul style="list-style-type: none"> <li>• Verify correct spark plug</li> <li>• Replace if necessary</li> <li>• Swap with another cylinder</li> </ul>
<b>Secondary circuit: (wiring, M73-cap, rotor)</b>	<ul style="list-style-type: none"> <li>• Wet or moist due to water infiltration.</li> <li>• High resistance due to corrosion.</li> </ul>		<ul style="list-style-type: none"> <li>• Check water ingress, repair, replace</li> <li>• Check resistance value, replace</li> </ul>
<b>Ignition Coil(s):</b>	<ul style="list-style-type: none"> <li>• Secondary/Primary Circuits open or shorted.</li> <li>• Housing cracked, damaged.</li> </ul>	Secondary and Primary	<ul style="list-style-type: none"> <li>• Inspect and replace if necessary</li> <li>• Swap with another cylinder</li> </ul>
<b>Ignition Coil &amp; Engine Harness Connectors</b>	<ul style="list-style-type: none"> <li>• Power supply, Primary control and ground (shunt signal) circuits impaired.</li> </ul>	Primary Ignition & Term 4A feed-back Preset Measurements	<ul style="list-style-type: none"> <li>• Look for open, loose connector, corrosion, crossed or backed out pins (also consider ignition unloader or ECM relay on MY97 and newer cars).</li> <li>• Determine defective condition, repair or replace.</li> </ul>

- A secondary ignition oscilloscope display provides vital information about the ignition system's condition.
- Follow the precautions in REP 12 00 Instructions for working on the ignition system.
- Use the following scope patterns as a guideline for ignition system diagnosis.



Evaluation of secondary signal amplitude at idle speed.

1. Normal Ignition Voltage Peak: **Spark Plug is OK**
2. Low Ignition Voltage Peak: **Gap too small (defective)**
3. High Ignition voltage peak: **Gap too large (defective)**

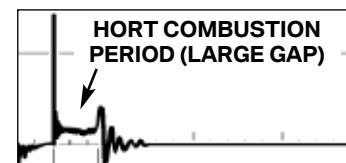
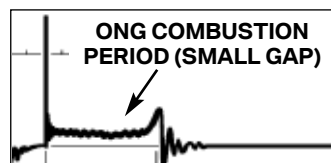
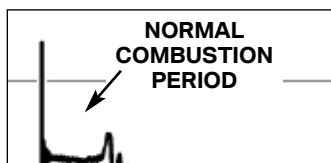

## ENGINE MECHANICAL SYSTEMS

COMPONENT	POSSIBLE CONDITION	TEST	CORRECTION
<b>Pistons, Rings, Valves, Camshaft:</b>	<ul style="list-style-type: none"> <li>Hole in piston crown, ring(s) broken, valve(s) not seating, valve(s) bent, valve spring(s) broken, camshaft lobe cracked, etc.</li> </ul>	<ul style="list-style-type: none"> <li>Idle Quality - Rough Running Preset.</li> <li>Cylinder compression &amp; leakdown tests.</li> </ul>	<ul style="list-style-type: none"> <li>Correct condition as required.</li> </ul>
<b>Hydraulic Valve Actuator (HVA):</b>	<ul style="list-style-type: none"> <li>HVA oil bore restricted or blocked.</li> <li>Engine oil pressure builds up too slow.</li> <li><b>Intermittent Misfire Fault</b> - Not Currently Present.</li> <li>HVA binding/sticking in bore.</li> </ul>	<ul style="list-style-type: none"> <li>Idle Quality - Rough Running Preset.</li> <li>Listen to HVA</li> <li>Check Oil Pressure</li> <li>Cylinder leakdown</li> </ul>	<ul style="list-style-type: none"> <li>Always consider mechanical components when diagnosing misfire.</li> <li>Inspect for scoring.</li> </ul>
<b>Vacuum Leaks:</b>	<ul style="list-style-type: none"> <li>Unmetered vacuum leaks causing a <b>“lean”</b> operating condition. Possible <b>“Excessive Mixture Deviation”</b> fault codes.</li> </ul>	<ul style="list-style-type: none"> <li>Idle Quality - Rough Running Preset. Test for vacuum leaks per Repair Instr. and SI B on <b>“Crankcase Ventilation”</b>.</li> <li>Interpret Add. &amp; Multiple adaptation values</li> </ul>	<ul style="list-style-type: none"> <li>Correct condition as required.</li> </ul>

## FUEL QUALITY, DELIVERY, INJECTION & EVAPORATIVE SYSTEMS

COMPONENT	POSSIBLE CONDITION	TEST	CORRECTION
<b>Fuel (quality):</b>	<ul style="list-style-type: none"> <li>Contaminated fuel. (water, other non combustible).</li> </ul>		<ul style="list-style-type: none"> <li>Clean fuel system, replace fuel.</li> </ul>
<b>Fuel Delivery:</b>	<ul style="list-style-type: none"> <li>Fuel pump delivery pressure low, restriction in fuel line to fuel rail or running loss valve.</li> <li>Fuel filter restricted (clogged).</li> <li>Low fuel in tank.</li> </ul>	<ul style="list-style-type: none"> <li>Check fuel pressure &amp; volume.</li> <li>Check fuel pump power and ground</li> </ul>	<ul style="list-style-type: none"> <li>Determine restriction/flow reduction, replace component as necessary.</li> <li>Interpret Additive and Multiplicative adaptation values.</li> </ul>
<b>Running Loss Valve:</b>	<ul style="list-style-type: none"> <li>Valve stuck in “small circuit” position.</li> </ul>	<ul style="list-style-type: none"> <li>Check valve</li> </ul>	<ul style="list-style-type: none"> <li>Display “diagnosis requests” in DISplus and test valve for proper function, replace valve as necessary.</li> </ul>
<b>Fuel Injectors:</b>	<ul style="list-style-type: none"> <li>Leaking fuel injector pintle seats cause rich engine starts with hot ambient temperatures.</li> <li>Blocked (dirty) injector(s).</li> </ul>	<ul style="list-style-type: none"> <li>Ti Preset &amp; status page.</li> <li>Sec Ign scope pattern.</li> </ul>	<ul style="list-style-type: none"> <li>Check injectors for leakage.</li> <li>Swap suspect injector with another cylinder.</li> <li>Inspect injector, replace if necessary.</li> </ul>
<b>Fuel Pressure Regulator:</b>	<ul style="list-style-type: none"> <li>Regulator defective, causes fluctuation in the injected quantity of fuel causing mixture adaptation faults.</li> </ul>	<ul style="list-style-type: none"> <li>Fuel pressure</li> </ul>	<ul style="list-style-type: none"> <li>Check nominal fuel pressure value with engine operating under varied speeds.</li> </ul>
<b>Evaporative System:</b>	<ul style="list-style-type: none"> <li>Defective evaporative system vent causing fuel tank collapse and fuel starvation.</li> </ul>	<ul style="list-style-type: none"> <li>DISplus status, Evap test with pressure tool, purge valve func. test.</li> </ul>	<ul style="list-style-type: none"> <li>Check the fuel tank condition and vent line.</li> <li>Check Fresh Air Valve on TLEV E36 vehicles or LDP/DM TL and filter on ORVR vehicles for proper system “breathing”.</li> </ul>

## IMPLAUSIBLE ECM CONTROL FUNCTION OR SENSOR INPUT SIGNALS

COMPONENT	POSSIBLE CONDITION	TEST	CORRECTION
<b>Crankshaft Position Sensor or Increment Wheel:</b>	<ul style="list-style-type: none"> <li>• Implausible signal for misfire detection.</li> <li>• Increment wheel loose or damaged (internal on M44, M52 and M54, external on M62 &amp; M73).</li> <li>• Air gap between sensor and wheel.</li> <li>• Noticeable at higher rpm.</li> </ul>	<ul style="list-style-type: none"> <li>• ISTA preset measurement.</li> </ul>	<ul style="list-style-type: none"> <li>• Determine defective sensor or increment wheel and replace.</li> </ul>
<b>Catalyst Damaged:</b>	<ul style="list-style-type: none"> <li>• Excessive exhaust back pressure (bank specific fault present, more noticeable under heavy load and high rpm).</li> </ul>	<ul style="list-style-type: none"> <li>• ISTA preset measurement of oxygen sensor.</li> <li>• Back pressure test per SI B with Special Tool.</li> </ul>	<ul style="list-style-type: none"> <li>• Determine catalyst condition, replace or repair as necessary.</li> </ul>
<b>Oxygen Sensor:</b>	<ul style="list-style-type: none"> <li>• Excessive mixture deviation, <b>possible vacuum leaks.</b></li> </ul>	<ul style="list-style-type: none"> <li>• Monitor oxygen sensor signal via DIS preset.</li> </ul>	<ul style="list-style-type: none"> <li>• Swap sensor from other bank (if applicable) and see if fault transfers to other bank.</li> </ul>
<b>Engine Control Module</b>	<ul style="list-style-type: none"> <li>• Internal control module fault.</li> <li>• Misfire Reprogramming.</li> </ul>	<ul style="list-style-type: none"> <li>• Check fault memory.</li> <li>• Refer to SI B</li> </ul>	<ul style="list-style-type: none"> <li>• Highly unlikely but must be considered.</li> <li>• Check Model/Prod range - reprogram</li> </ul>

### ***When diagnosing a Misfire fault code, Remember:***

**“Misfire” is caused by a defect in the internal combustion engine or a defect in the control of the engine operation.**

**“Misfire” is the result of improper combustion (variation between cylinders) as measured at the crankshaft due to:**

- Engine mechanical defects; breakage, wear, leakage or improper tolerances.
- Excessive mixture deviation; air (vacuum leaks), fuel and all the components that deliver air/fuel into the combustion chambers.
- Faulty ignition; primary, secondary including spark plugs.
- Faulty exhaust flow; affecting back pressure.
- Tolerance parameters; ECM programming.

**A Misfire fault code(s) is the “symptom” of a faulty input for proper combustion. When diagnosing a misfire, review the charts to assist you in finding the faulty input.**



# SI B 12 06 10 N54 - Misfire Faults, Diagnosis with ISTA

## N54 Engine Diagnostic Fault Tree Version 06\_04\_10

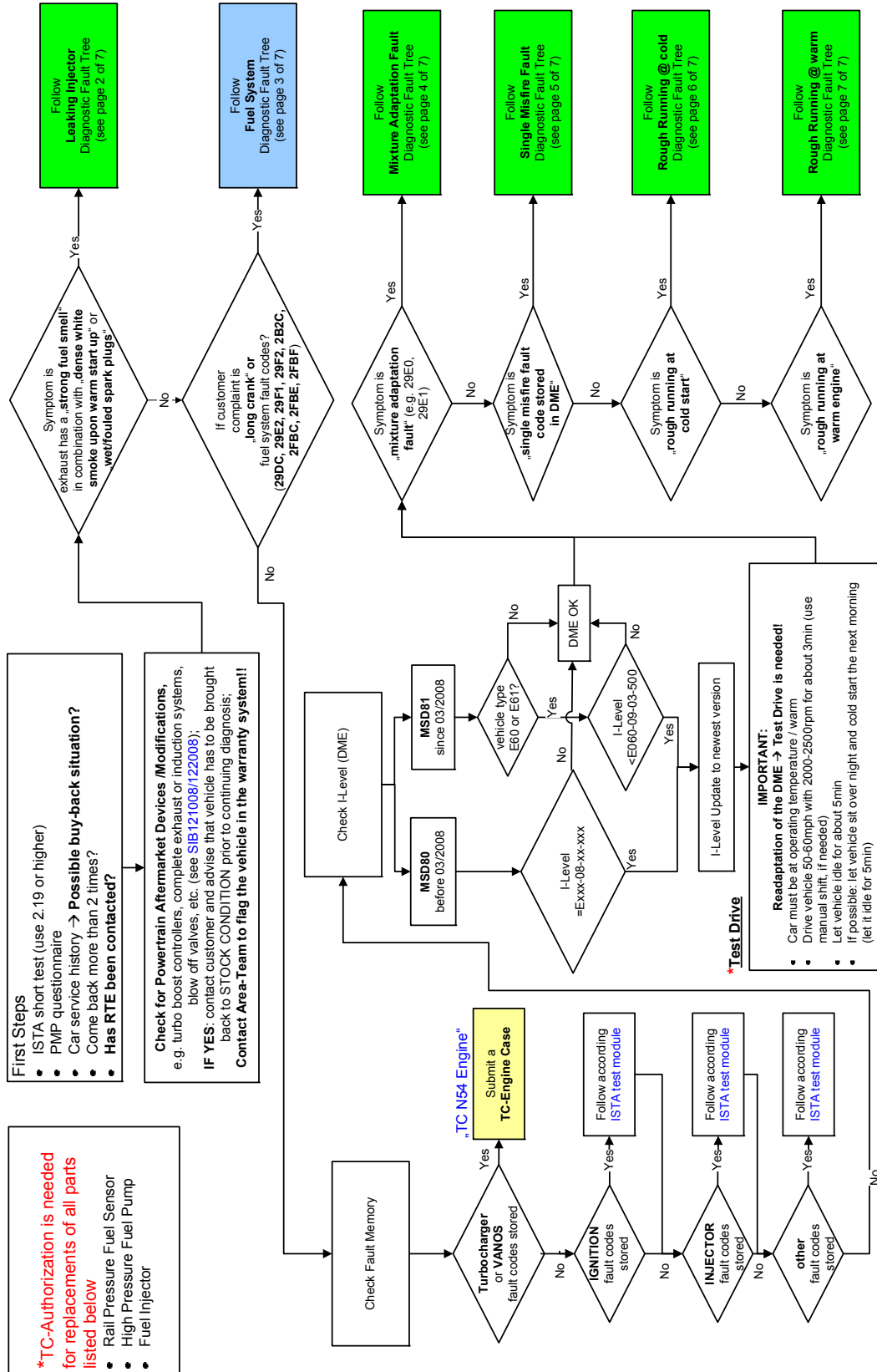

DFT – Leaking Injector

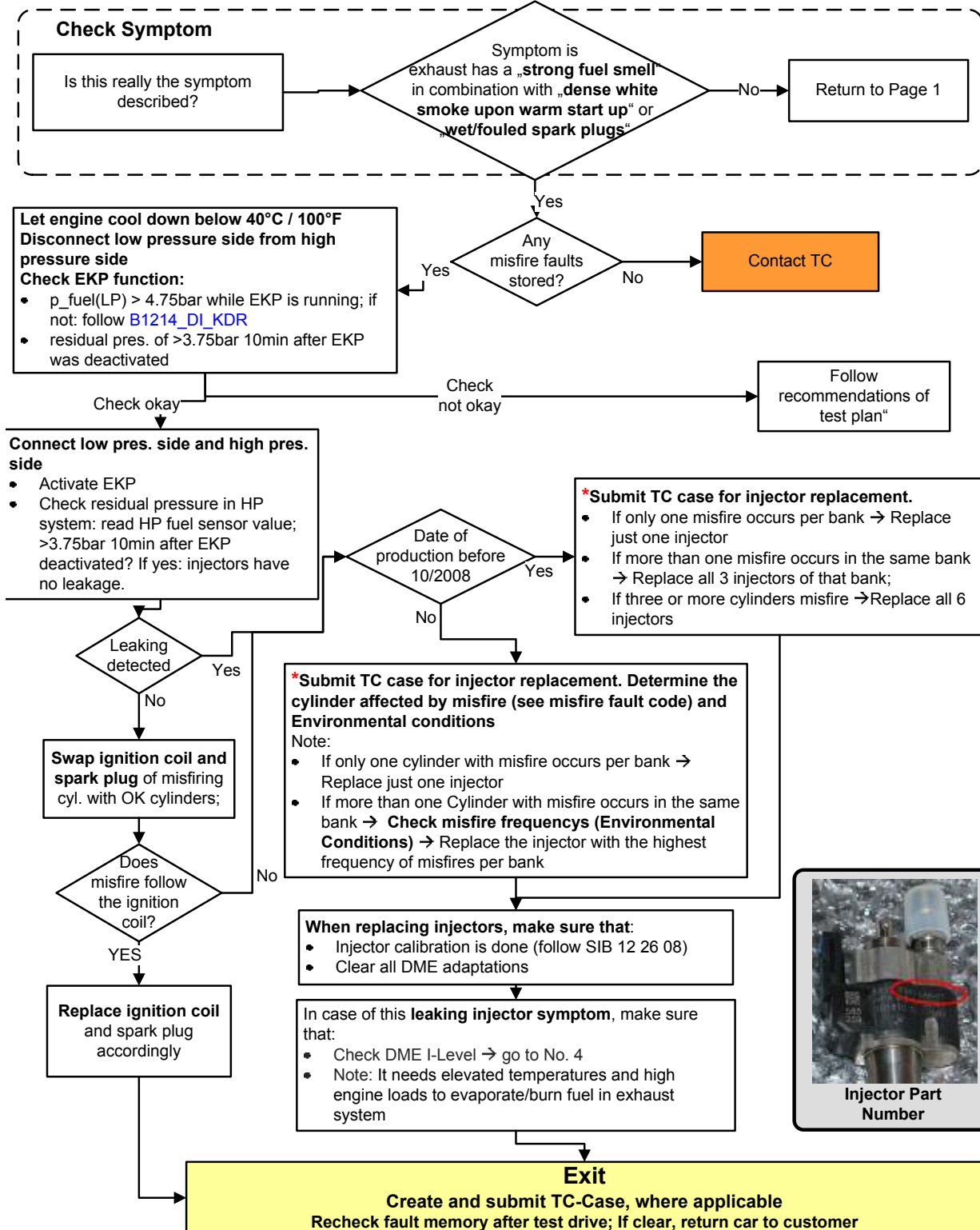

# SI B 12 06 10 N54 - Misfire Faults - Diagnosis with ISTA

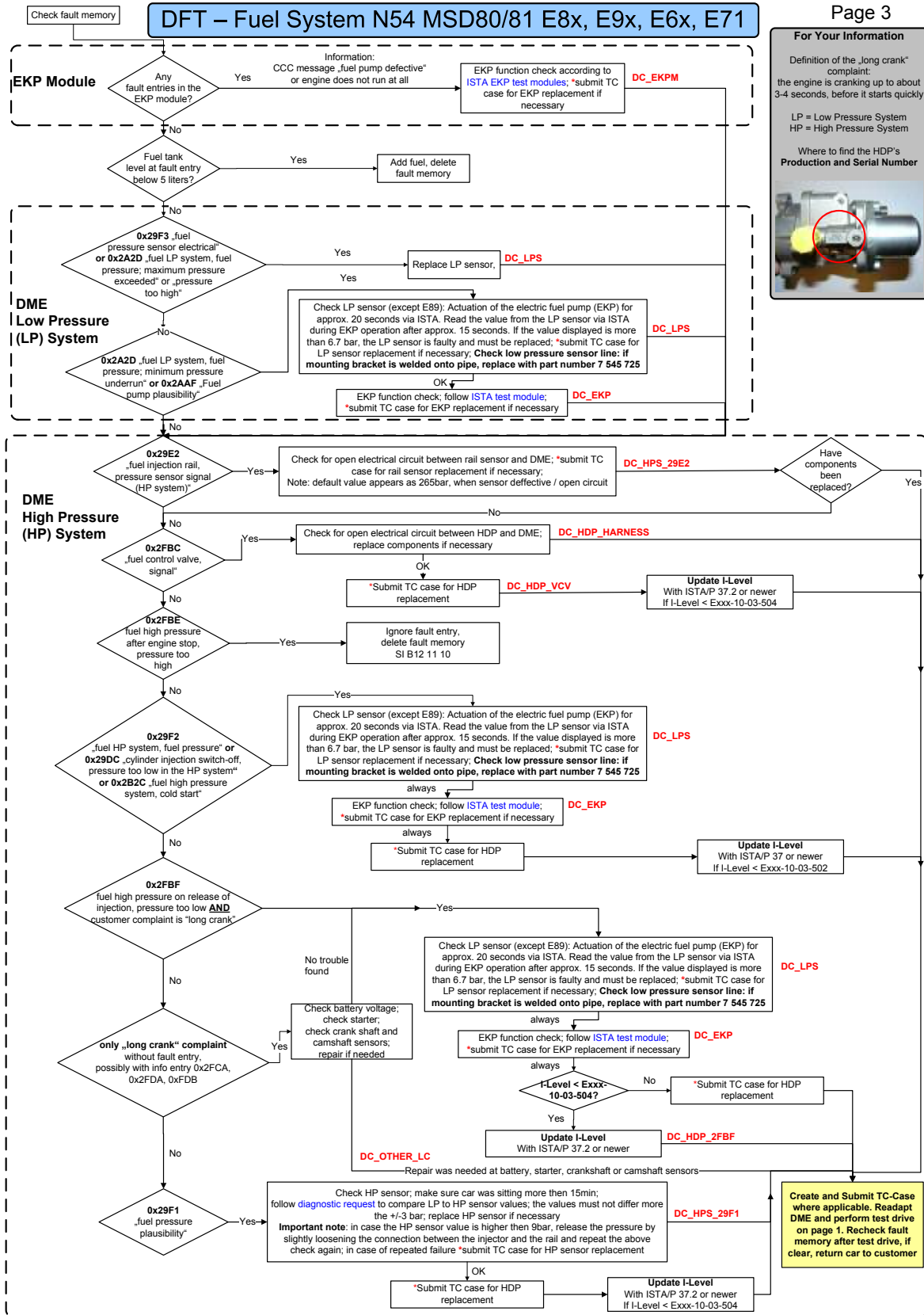

# SI B 12 06 10 N54 - Misfire Faults, Diagnosis with ISTA

## DFT – Fuel System N54 MSD87 F01, F02

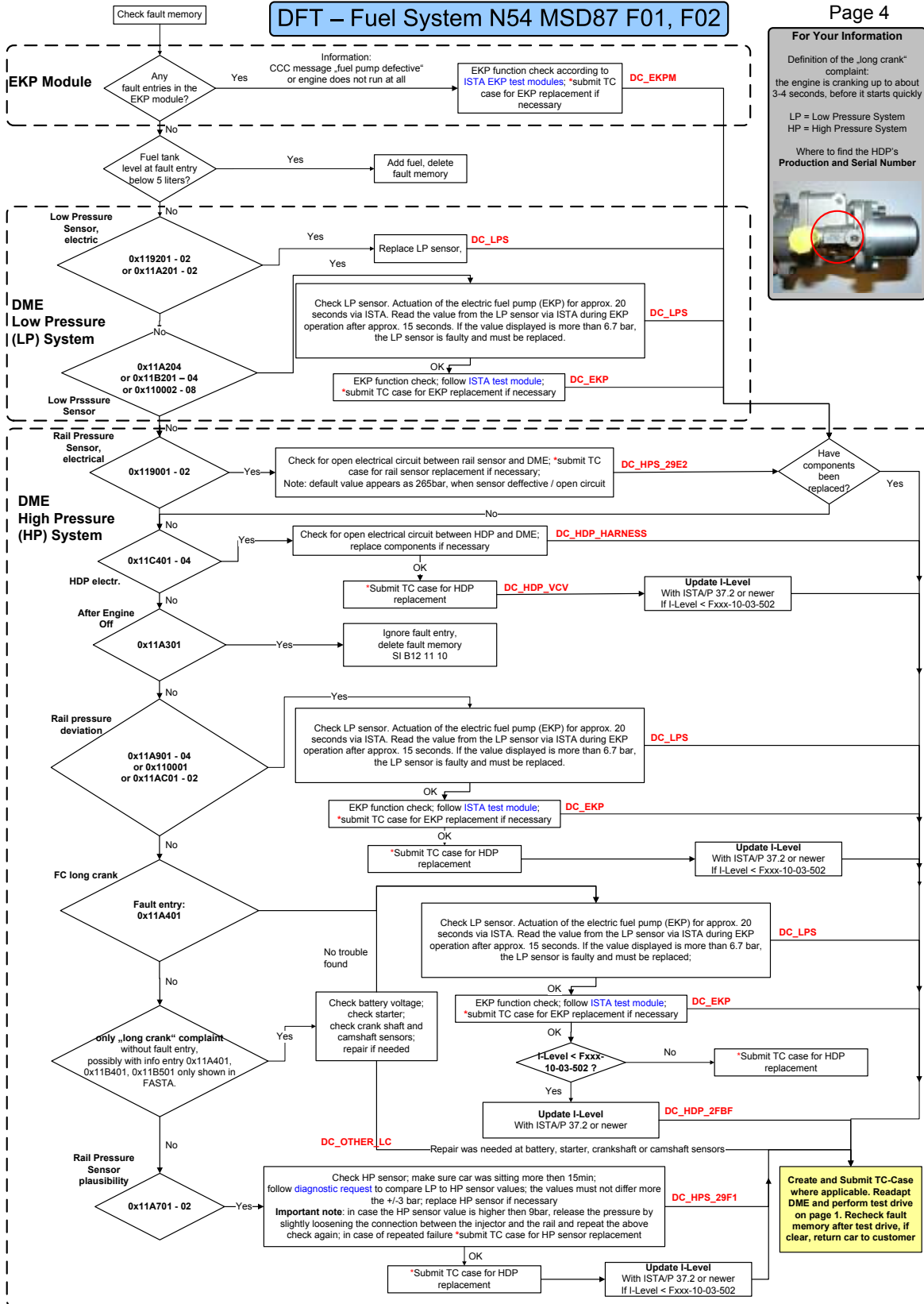

**DFT – Mixture Adaptation Fault**

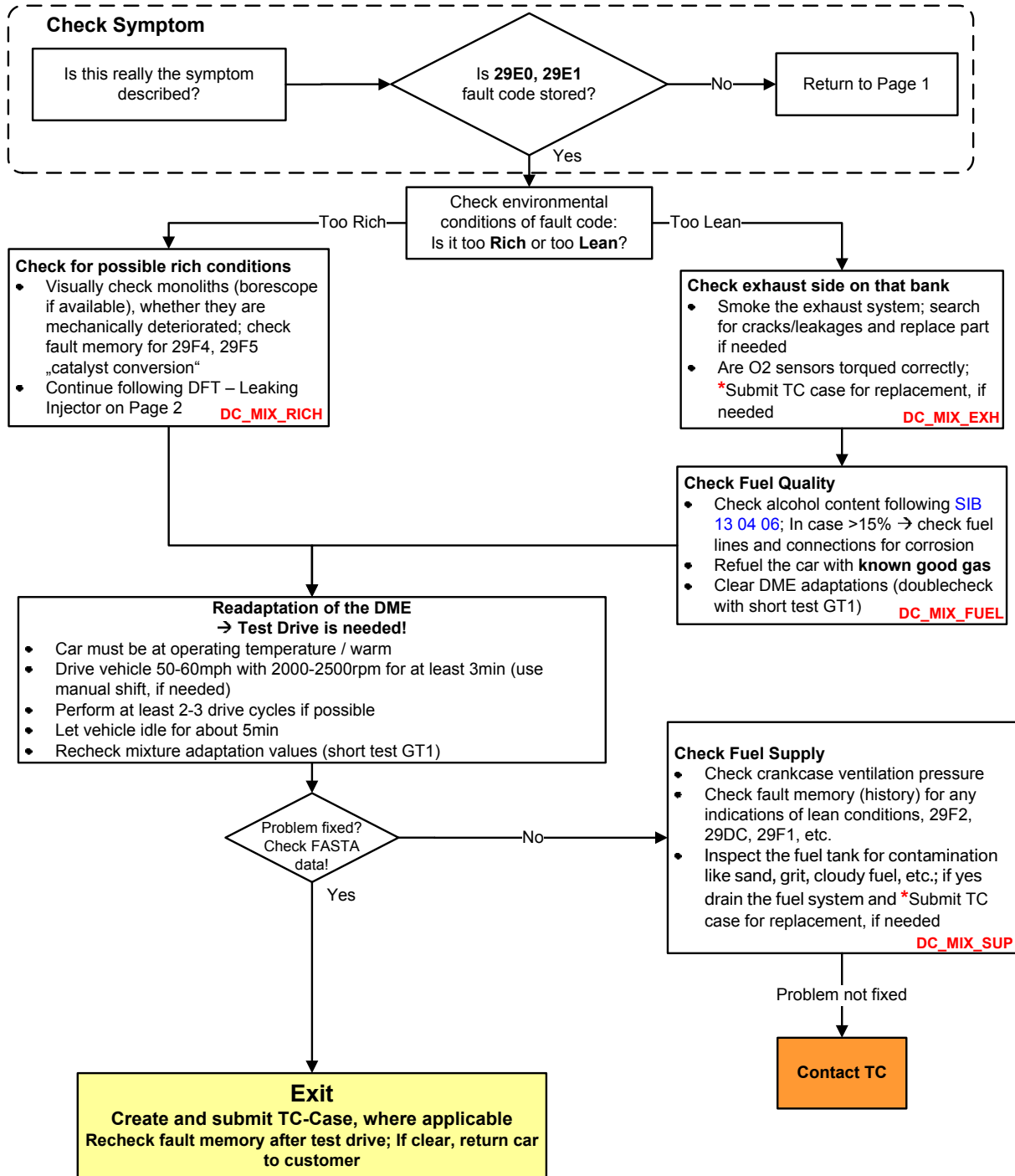

**DFT – Single Misfire Fault**

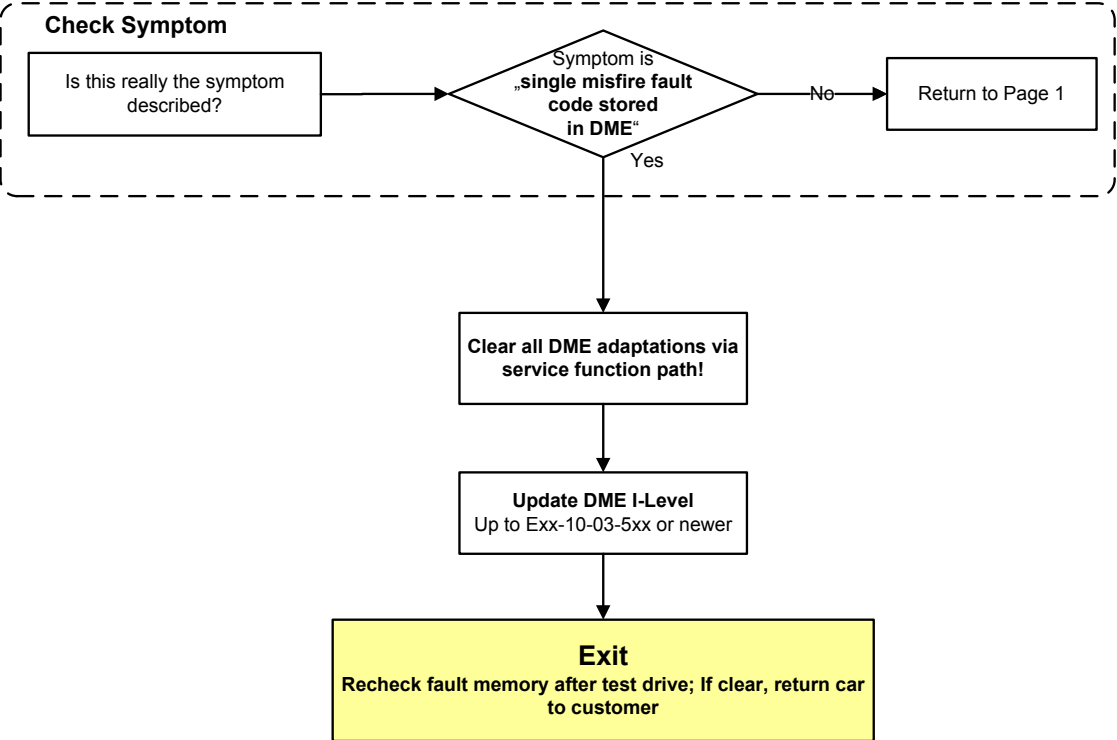

**DFT – Rough Running @ Cold Start**

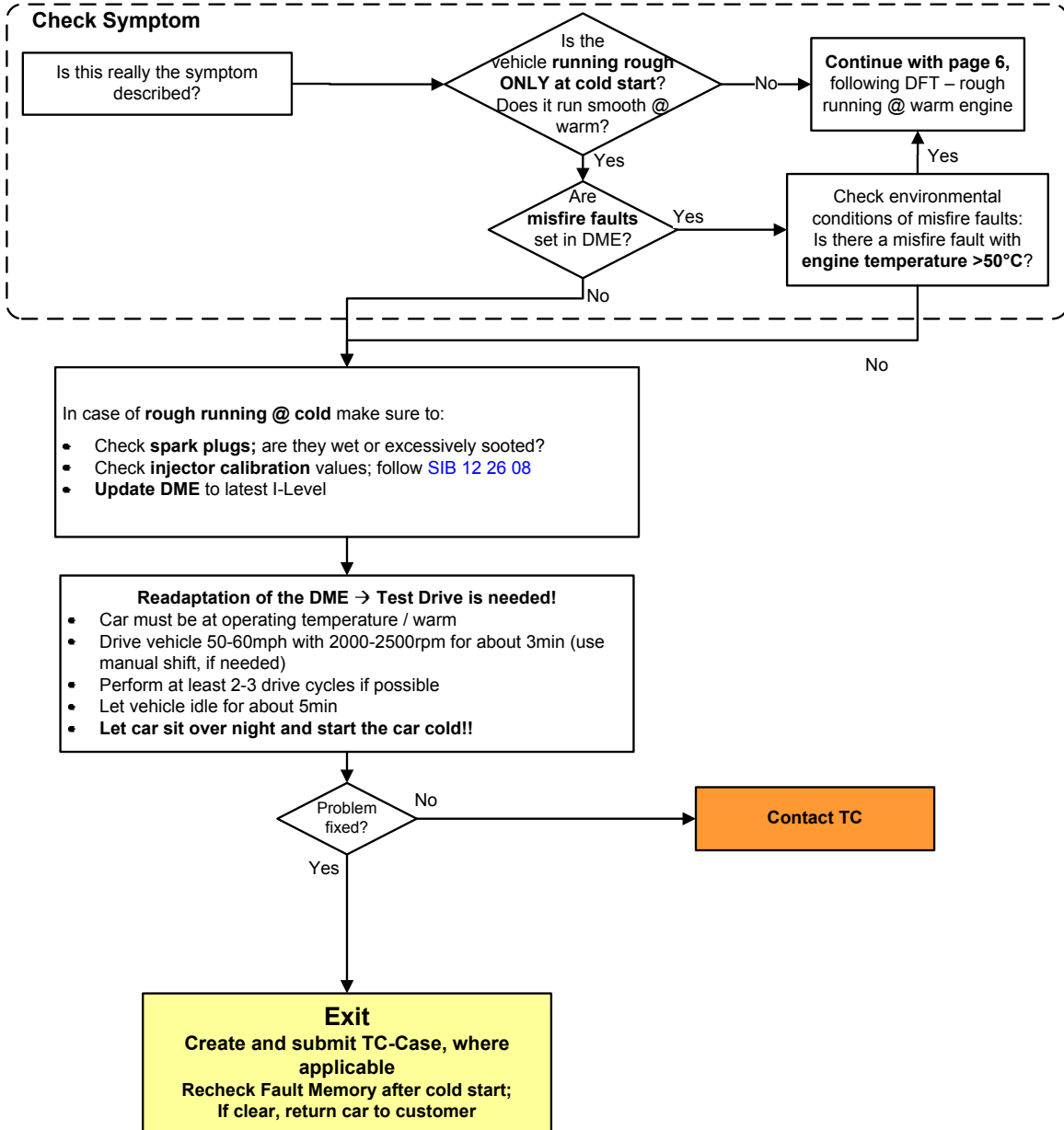

# SI B 12 06 10 N54 - Misfire Faults, Diagnosis with ISTA

**DFT – Rough Running @ Warm Engine**



**IMPORTANT:**  
**Test Drive is needed!**  
 • Engine must be warm  
 • Drive vehicle at different loads and speeds!

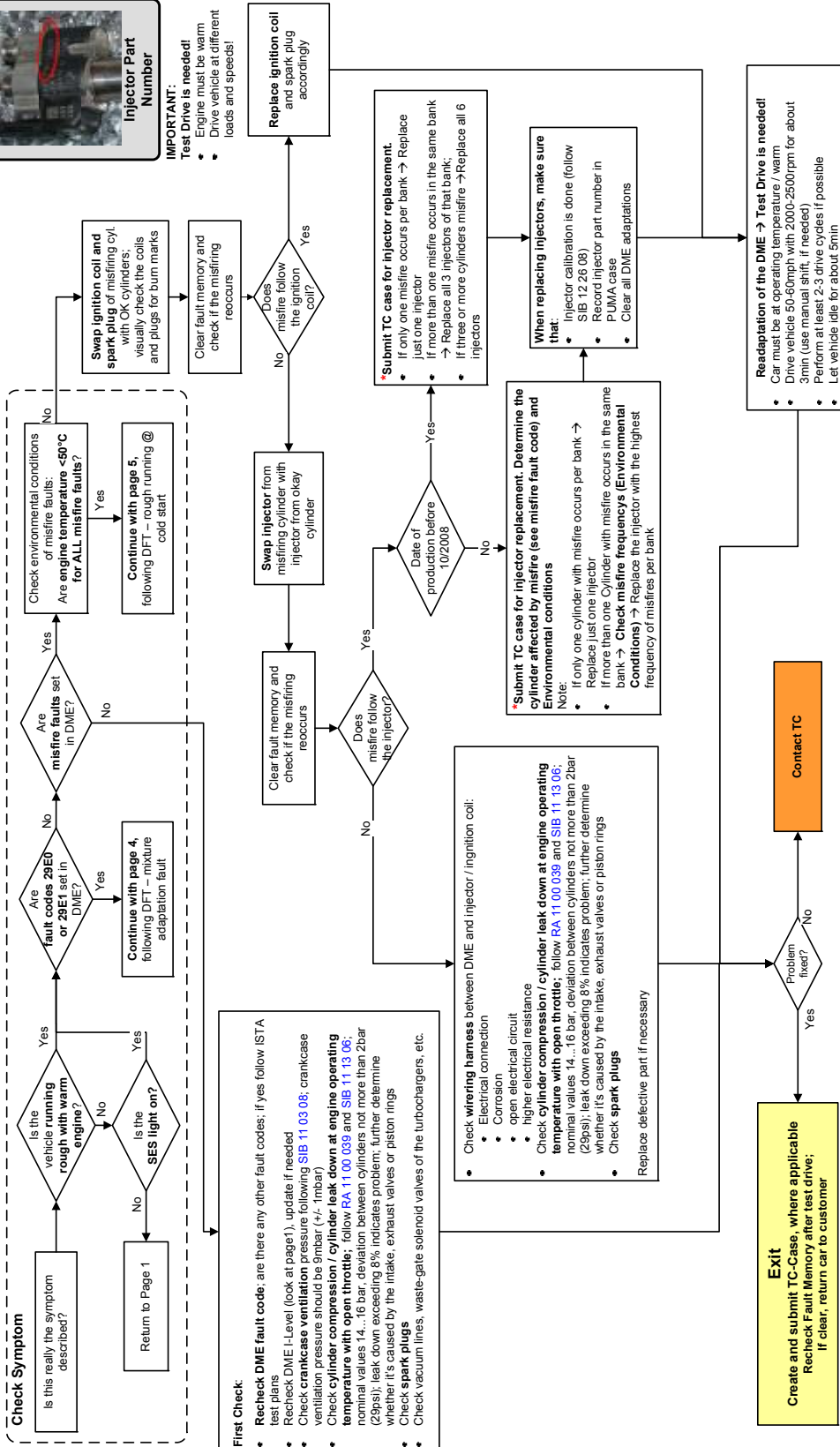



# SI B 12 11 10 N54, N54T, N55 - Diagnosis for HDP High-pressure Faults

## DFT – Fuel System N55 E8x, E9x, E7x

Page 1

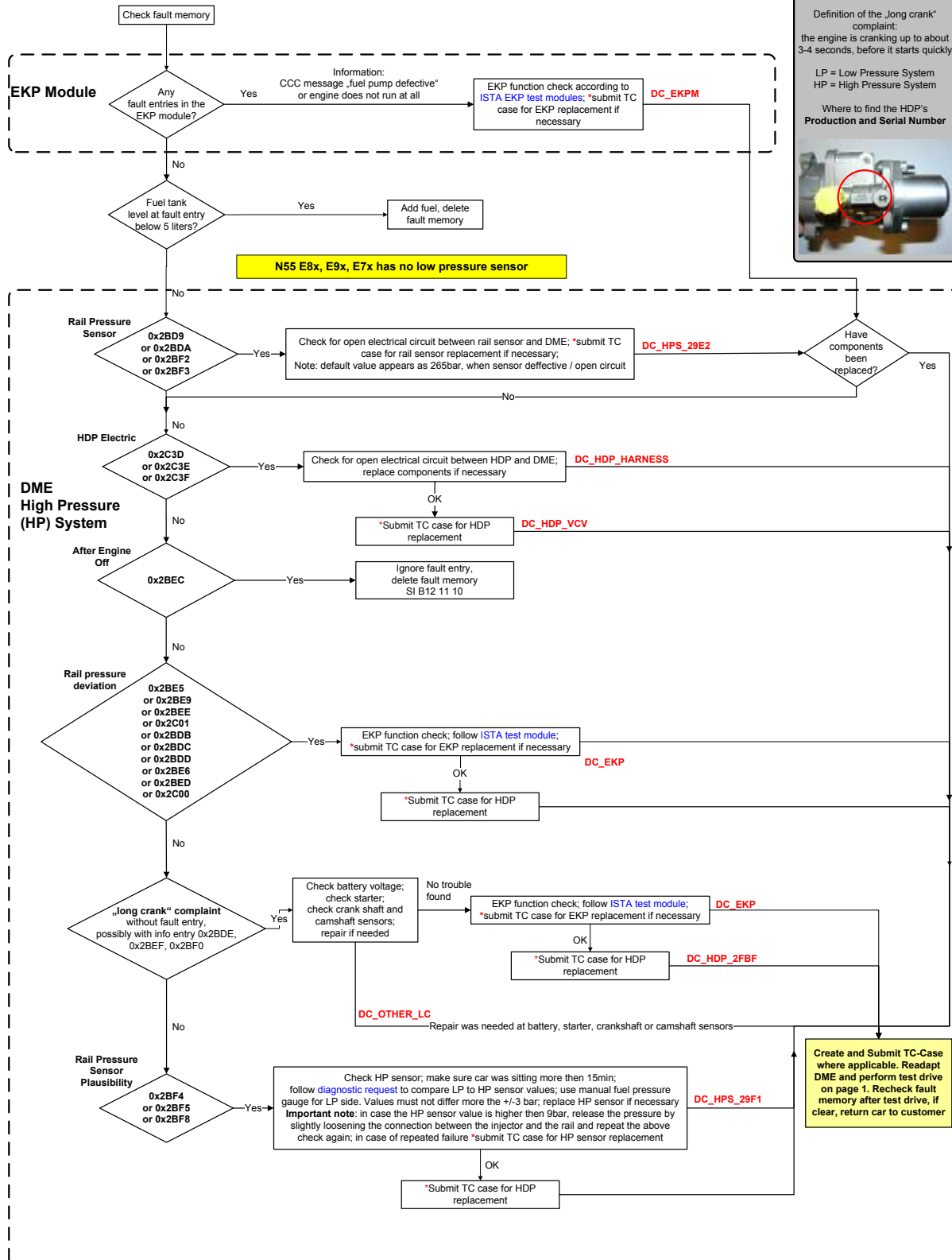

# SI B 12 11 10 N54, N54T, N55 - Diagnosis for HDP High-pressure Faults

